

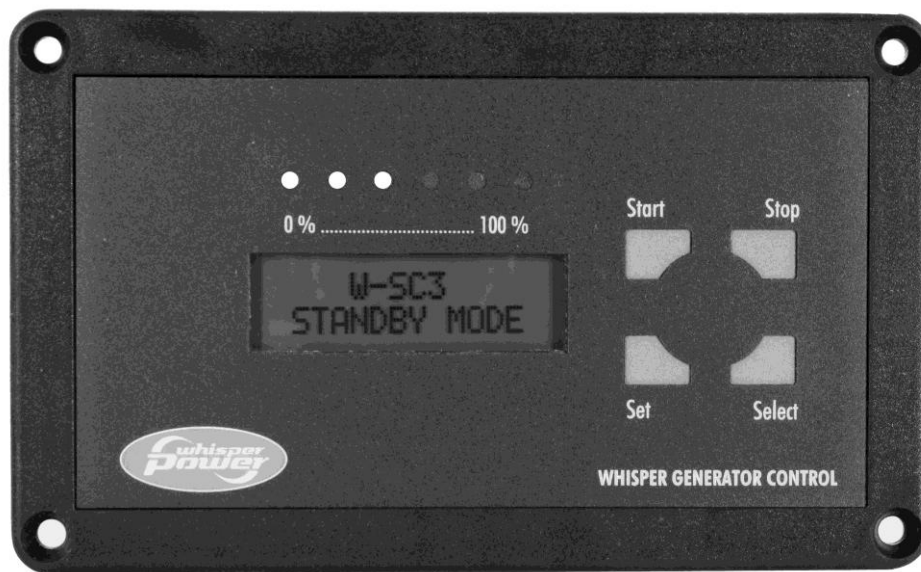

OPERATING MANUAL

Digital Diesel Control

Remote control panel for Whisper generator sets



Art. nr. 40200261

WHISPER POWER BV
Kelvinlaan 82
9207 JB Drachten
Netherlands
Tel.: +31-512-571550
Fax.: +31-512-571599
www.whisperpower.eu

ENGLISH:	PAGE 1
NEDERLANDS:	PAGINA 41
DEUTSCH:	SEITE 81
FRANÇAIS:	PAGE 121

English / v 1.3 / February 2009

The *Digital Diesel Control* is the remote control panel of your Whisper generator.



Load bar (chapter 2.3)

The *Load bar* displays the approximate load that is connected to the generator in proportion to the maximum available power. Each LED represents 20 % of the available power.

Red LED (chapter 2.4)

When the *red LED* blinks, the Whisper generator is in overload. If the connected load is not reduced, the Whisper generator stops automatically after a few seconds.

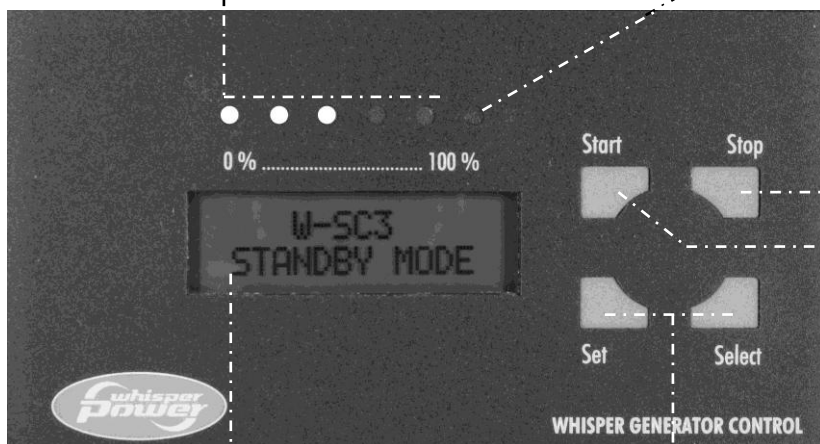

Stop (chapter 2.2). Press *Stop* shortly to stop the Whisper generator at any time.

Start (chapter 2.1). Press *Start* shortly to start the Whisper generator at any time.

LCD display (chapter 2.4)

The actual status and user specific information of the Whisper generator is displayed at the *LCD display*. When two blinking stars (✕) are shown, the *autostart function* (chapter 9) or the *interval mode* (chapter 10) is activated.

Select and Set (chapter 2.5)

Generator set is running:

- Press the *Select* button shortly to scroll through the *monitor menu* (chapter 4).

Generator set is not running:

- Press the *Select* button shortly to scroll through the *stand-by menu* (chapter 3) and the *historical data menu** (chapter 5).
- Hold the *Select* button pressed for approximately 3 seconds to enter the *Select menu** (chapter 6). From here you can enter the advanced sub-menus. You can change several advanced set-points by means of the *Set* button. You can leave these submenus by pressing *Stop* shortly.

* These menus are only accessible when the Whisper generator is not running and the access to these menus is allowed at the set-up menu (see chapter 2.6).

TABLE OF CONTENTS

English / v 1.3 / February 2009

1	GENERAL INFORMATION	6
1.1	Use of this manual	6
1.2	Introduction and features	6
1.3	Validity of this manual (version 1.3)	7
2	BASIC OPERATION	8
2.1	Start button	8
2.2	Stop button	8
2.3	Load bar	8
2.4	LCD display	8
2.5	Select- and Set-button	9
2.6	Restricted accessibility to the menus	9
2.7	Lock mode	9
2.8	Start Cycle	11
2.9	Stop Cycle	12
2.10	Generator maintenance	12
2.11	Maintenance of the Digital Diesel Control	12
3	STAND-BY MENU	13
3.1	Initial level	13
3.2	Start battery voltage	13
3.3	Trigger level autostart function (start battery)	13
3.4	Voltage of the second battery	13
3.5	Trigger level autostart function (second battery)	14
3.6	Time till start	14
3.7	Clock	14
3.8	Time before maintenance	14
3.9	Runtime	14
3.10	Historical data menu	14
4	MONITOR MENU	15
4.1	Initial level	15
4.2	Actual Voltage, Amps, Frequency and Load	15
4.3	Actual Load	15
4.4	RPM and frequency	15
4.5	Start battery voltage	16
4.6	Trigger level autostart function (start battery)	16
4.7	Second battery voltage	16
4.8	Trigger level autostart function (second battery)	16
4.9	Actual runtime	16
4.10	Time till stop	16
4.11	Day and time	16

5	HISTORICAL DATA MENU	17
5.1	Total run time	17
5.2	Average runtime	17
5.3	Number of successful start attempts	17
5.4	Number of failed start attempts	17
5.5	Number of autostarts (start battery)	17
5.6	Number of autostarts (second battery)	18
5.7	Deepest start battery voltage	18
5.8	Number of deep voltage hits	18
5.9	Latest warning	18
5.10	Latest failure	18
6	SELECT MENU	19
7	ENERGY MENU	20
7.1	Reset to factory settings	20
7.2	Alarm triggered by a failure on/off	20
7.3	Alarm triggered by a warning on/off	20
7.4	Test alarm output on/off	21
7.5	Show warnings on/off	21
7.6	Low AC-voltage warning	21
7.7	High AC-voltage warning enable/disable	21
7.8	High AC-voltage warning	21
7.9	High AC-current warning	22
7.10	Low frequency warning	22
7.11	Start battery low voltage warning	22
7.12	Nominal voltage of the second battery	22
7.13	Second battery low voltage warning	22
8	ENGINE MENU	23
8.1	Reset to factory settings	23
8.2	Lift time of the fuel supply pump	23
8.3	Pre heat time	23
8.4	Maximum cranking time	23
8.5	Maximum number of start attempts	24
8.6	Starting error by-pass time	24
8.7	Pull to stop time	24
8.8	Set maintenance time	24
9	AUTOSTART MENU	25
9.1	Reset to factory settings	26
9.2	Autostart - Start battery on/off	26
9.3	Autostart - Second battery on/off	26
9.4	Silent Period on/off	27
9.5	Adjustment of the silent period	27
9.6	Adjustment of the autostart trigger points	28

10 INTERVAL MENU	29
10.1 Reset to factory settings.....	30
10.2 Interval Auto start ON/OFF.....	30
10.3 Repeat cycle	30
10.4 Interval begin.....	30
10.5 Interval end	30
11 DISPLAY MENU.....	31
11.1 Reset to factory settings.....	31
11.2 Set clock.....	31
11.3 Sleep mode	31
11.4 Lock mode.....	32
11.5 Language setting.....	32
11.6 Contrast.....	32
11.7 Firmware Panel	32
11.8 Firmware Control.....	32
12 SERVICE MENU	33
12.1 Clear maintenance time	33
12.2 Clear number of start attempts.....	33
12.3 Clear number of autostarts (start battery).....	33
12.4 Clear number of autostarts (second battery)	33
12.5 Latest battery warning	33
12.6 Alarm function delay time (start battery).....	34
12.7 Number of deep voltage hits (start battery)	34
12.8 Deepest voltage of the start battery	34
12.9 Clear deep voltage hits (start battery)	34
12.10 Alarm function delay time (second battery).....	34
12.11 Number of deep voltage hits (second battery)	34
12.12 Deepest voltage of the second battery	35
12.13 Clear deep voltage hits (second battery)	35
12.14 Service start.....	35
13 WARNING AND FAILURE CODES	36
14 TECHNICAL DATA	36
APPENDIX.....	37
INDEX.....	40
TROUBLE SHOOTING.....	40

1 GENERAL INFORMATION

1.1 Use of this manual

This operating manual serves as a guideline for the safe and effective operation of the **Whisper Power Digital Diesel Control**. Installation of the *Digital Diesel Control* is described in the *installation manual* of the Whisper generator set.

Operation of the *Digital Diesel Control* can be separated into three major parts:

- **Basic operations.** The most important functions of the Digital Diesel Control are explained in chapter 2. Read at least this chapter before you start operating the Digital Diesel Control!
- **Readout functions.** Chapters 3, 4 and 5 explain the *stand-by menu*, the *monitor menu* and the *historical data menu*. These menus offer you a quick overview of all actual and historical data of the Whisper generator set.
- **Advanced operations.** Several advanced operations which are accessible via the *select menu* are described from chapter 6 on.

1.2 Introduction and features

Whisper Generating Sets are standard supplied with a very advanced digital control system, named "*Digital Diesel Control*".

This system performs automatic starting and stopping, it offers many monitoring functions and shows a large number of actual and historical parameters. Further it supports faultfinding and maintenance.

The system includes a *control unit* ("*black box*") containing a microprocessor and a local control panel that are both on the generator set itself.

A remote control panel communicates with the *control unit* over a "plug in" communication cable that is in the delivery. The remote control panel shows information on a *LCD display*.

After connecting the remote panel to the generator set (plug in) the system is ready to be used and no settings are required:

- Just pushing the *Start* button shortly will initiate the start procedure. Each step in this procedure is displayed on the panel and shows for itself.
- Stopping is possible at any moment by pushing the *Stop* button shortly.
- While the generator set is running the *LCD display* shows the most important information about the output and load. The *Load bar* allows a one-glance observation of the load as well.
- When scrolling through the menu many more actual parameters can be monitored.
- A *red LED* lighting up indicates that a failure occurred. Detailed information about the failure is shown on the *LCD display*.
- In case of a failure the microprocessor will stop the engine. After stopping, the failure is shown on the *LCD display*. Restarting is only possible after correcting the failure and resetting the panel.

So far everything is very simple and for normal use we recommend to keep it this way.

However the system has many more features. The most important features have to do with automatic starting.

- The system is capable of monitoring a set of (independent) batteries starting the generating set when the battery voltage drops below a certain preset level.
- Also it is possible to have the generator set started and run according to a pre-programmed time schedule.

It is a well-known misunderstanding to think that automatic start functions make the operation of the generator set simpler. In the contrary the generator set will live its own life and you have to be sure that this is what you want! The generator set will start in your absence and also when the boat is in the dry dock for maintenance or when an other boat has moored aside just below your exhaust, if the automat is not manually override to do so!

Only use the automatic start functions when you really need this option. Installing and setting of automatic start options should only be executed by trained technical engineers.

1.3 Validity of this manual (version 1.3)

This operating manual (version 1.3) applies to Digital Diesel Control panels with Firmware version 2.06 and higher.

Firmware version of the Digital Diesel Control panel	Manual version
1.00 up to 1.17	1.1
2.00 up to 2.04	1.2
2.06 and higher	1.3

Under normal circumstances you will receive the correct operating manual with your panel. This means that the operating manual corresponds with the delivered Digital Diesel Control panel

Only if you have an earlier model of the Digital Diesel Control panel (firmware version up to 2.04), please refer to older manuals, which are available on our website:

www.whisperpower.eu. See chapter 11 to check the software version of the DDC panel.

2 BASIC OPERATION

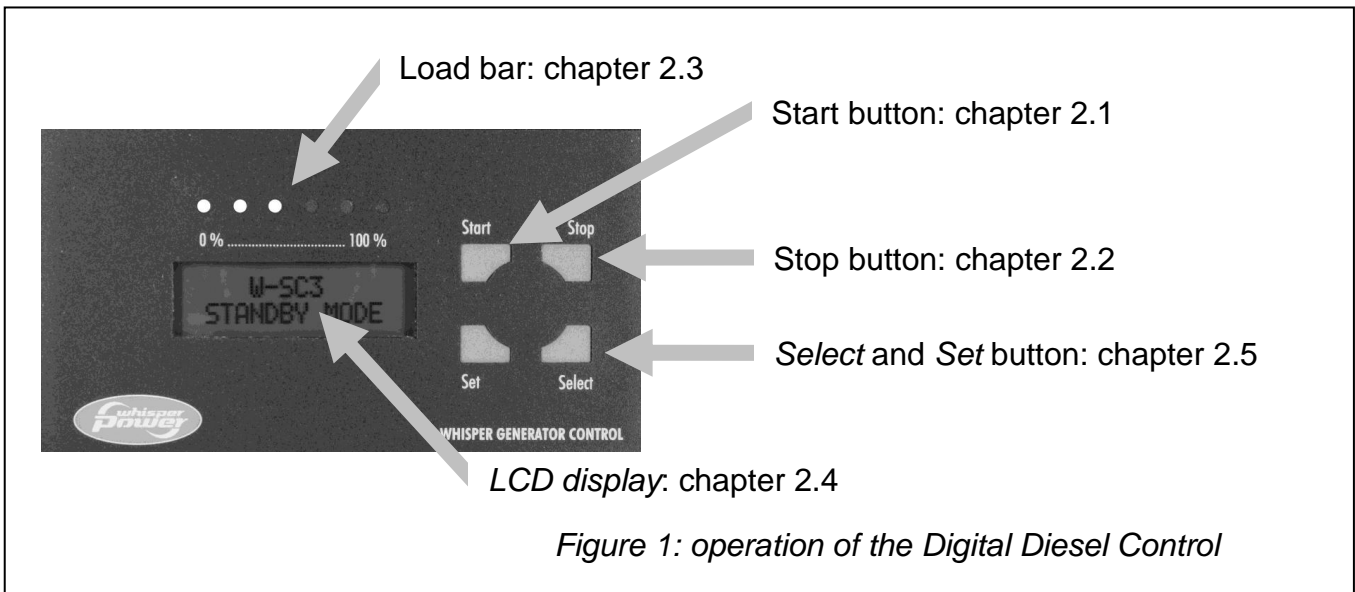

The *Digital Diesel Control* is the remote control panel of your Whisper generator set. The panel is connected to the control electronics of the generator set by means of a communication cable.

2.1 Start button

Press the *Start* button shortly to start the Whisper generator set at any time. Refer to chapter 2.8 for additional information about the generator start -cycle

2.2 Stop button

Press the *Stop* button shortly to stop the Whisper generator set at any time. Refer to chapter 2.9 for additional information about the generator stop -cycle

2.3 Load bar

The *load bar* displays the approximate load that is connected to the generator set in proportion to the maximum available power: the more LED's illuminate, the more load is connected to the generator set. Each LED represents 20 % of the available power. When the *red LED* blinks, the Whisper generator set is in overload. If the connected load is not reduced, the Whisper generator set stops automatically after a few seconds.

During a generator start- or stop-cycle, the *load bar* shows the countdown of the several steps.

2.4 LCD display

The actual status and user specific information of the Whisper generator set is displayed at the LCD display.

When two blinking stars (×) are shown, the *autostart function* (see chapter 9) or the *interval mode* (see chapter 10) is activated

2.5 Select- and Set-button

The *Digital Diesel Control* offers several menus to adjust the settings to control the *Whisper generator set*. See figure 2 for an overview of all menus.

The navigation through these menus and the adjustment of parameters is done by means of the *Select-* and *Set-* button. There is a distinction between pressing the *Select-* and *Set-* button for a short and a long time:

- **Select (short).** In general, when pressed shortly (less than 3 sec.), you can scroll through the (sub-) menus.
- **Set (short).** Depending on the shown data, when you press the *Set-*button shortly (less than 3 sec.), you can:
 1. Enter a displayed submenu
 2. Leave a (sub-)menu at the *Exit menu*;
 3. Adjust a value
- **Select (long).** Pressing the *Select* button for at least three seconds has two functions:
 1. From the *stand-by menu*, you can enter the *select menu* (see chapter 6);
 2. You can change the direction of the arrow in the right part of the display when a value needs to be adjusted. If the arrow is pointing downwards (↓) the value can be decreased. If the arrow is pointing upwards (↑) the value can be increased.
- **Set (long).** At certain (sub-)menus specific counters or historical data can be reset by holding the *Set* button pressed for at least three seconds.

2.6 Restricted accessibility to the menus

Wrong settings of the *Digital Diesel Control* may lead to hazardous situations.

Therefore availability of, and accessibility to settings of the *select menu*, the *autostart menu* and/or the *interval menu* might be restricted by the installer (or owner) at the set-up menu. See figure 2.

Refer to the appendix to change the accessibility to these menus.

2.7 Lock mode

To protect the *Digital Diesel Control* against unintended adjustment of critical variable set points, the *lock mode* is activated every time you leave a (sub)menu. When activated, critical settings cannot be changed when the *lock-mode symbol* (⌘) is shown at the right upper corner of the display.

See chapter 11.4 to disable the *lock mode*.

Only allow changes in the settings to be carried out by qualified persons.

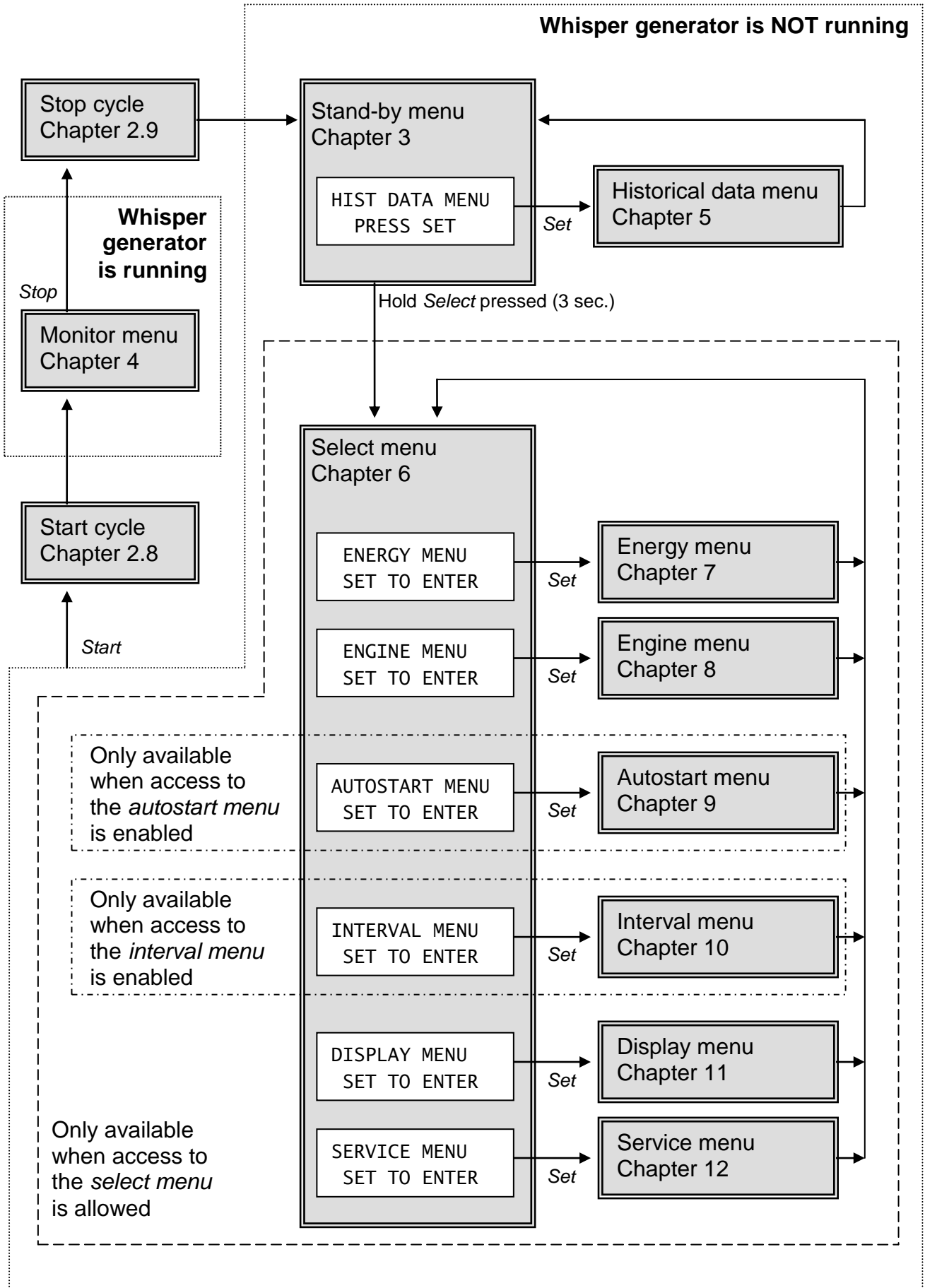
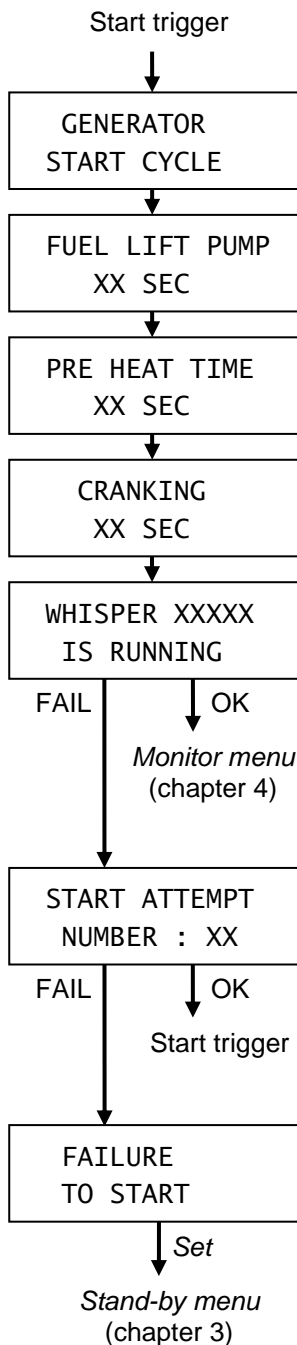

Figure 2: menu structure of the Digital Diesel Control

2.8 Start Cycle



There are four ways to trigger the start cycle of the generator set*:

- Manually, by pressing *Start* shortly (see chapter 2.1);
- Automatically, triggered by the *autostart function* (see chapter 9);
- Automatically, triggered by the *interval mode* (see chapter 10);
- Automatically, after a failed start attempt.

In all cases the start cycle is similar. When the generator set is started, the display shows all stages of the start cycle. See left figure.

The LED-indicators of the *load bar* show a countdown of the remaining time of each stage.

See chapter 8 to adjust the settings of the start cycle

When the generator set is started successfully, the *initial level* of the *monitor menu* is displayed (chapter 4).

When the generator set failed to start, all stages of the start cycle are repeated as often as adjusted (see chapter 8.5 to adjust the maximum number of start attempts).

When the generator set is still not running OK after the maximum number of start attempts, it is stopped and a failure code is displayed. See chapter 13 for an overview of all possible failure code.

Press *Set* shortly to go to the *stand by menu*.



NOTE: A generator start is considered to be successful if:

- The output frequency of the generator set is >25Hz or the generator set produces a battery charging voltage *and*
- None of the sensor switches on the generator set detects an error

* The generator can also be started manually by means of a *service start*. See chapter 12.14 for information.

2.9 Stop Cycle

There are five ways to stop the generator set:

- Manually, by pressing *Stop* shortly (see chapter 2.2);
- Automatically, triggered by the *autostart function* (see chapter 9);
- Automatically, triggered by the *interval mode* (see chapter 10);
- Automatically, caused by a hardware failure of the generator set (see chapter 13 for an overview of all *failure codes*.);
- Automatically, after a failed start attempt (see chapter 2.8)

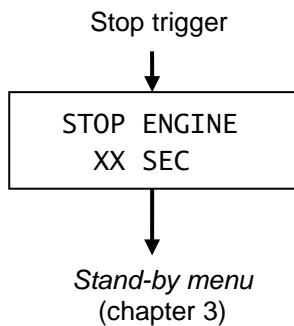

In all cases the stop cycle is similar: the display shows STOP ENGINE. See left figure. At the same time all indicators of the *load bar* flash simultaneously.

See chapter 8.7 to adjust the settings of the stop time (model **W-SC3.5** only; all other models: 10 seconds, fixed)

After the generator set was stopped, the *Digital Diesel Control* returns to the *stand-by menu*

2.10 Generator maintenance

The *Digital Diesel Control* is equipped with an hour counter to indicate the time before maintenance. It will help you to schedule maintenance.



IMPORTANT: The maintenance time interval is not only determined by the number of running hours, but also by factors like environmental conditions, average runtime, connected load, etcetera. The *Digital Diesel Control* does not take account of these factors. Refer to the user's manual of the *Whisper generator* for additional information about service maintenance to the generator set.

Refer to chapter 12.1 (clear maintenance time) to reset the counter of the maintenance time after the generator set was serviced. This submenu is accessible by entering the *select menu* followed by the *service menu* (see chapter 6).

2.11 Maintenance of the Digital Diesel Control

No specific maintenance to the Digital Diesel Control is required. If necessary, use a soft clean cloth to clean the display. Never use any liquids, acids and/or scourers.

3 STAND-BY MENU

This chapter describes the functions of the *stand-by menu*. The *stand-by menu* offers the user a brief overview of the status of the generator set. This menu is not available when the generator set is running.



Touch the *Select* button shortly to scroll through the levels as described below.

W-SC3.5
STAND BY MODE

Select

START BATTERY
VOLTAGE 12.45V

Select

START BAT. LOW
SETTING 11.50V

Select

TENSION BAT2
12.20V

Select

3.1 Initial level

When the system is in rest (the generator set is not running), the *initial level* is displayed. The *initial level* shows:

- The identification of the Whisper generator model
- The mode that is active at the moment (*stand by mode*, *automatic mode* or *silent period*)

When *automatic mode* is active, two blinking stars (✱) are shown, which means that the *autostart function* (see chapter 9) or the *interval mode* (see chapter 10) is activated.

3.2 Start battery voltage

Press *Select* once to show the actual battery voltage of the generator's start battery (BAT1). When no button is touched during 40 seconds, the display returns to the *initial level* automatically

3.3 Trigger level autostart function (start battery)

Only displayed when the *autostart function* is activated (see chapter 9). This value marks the voltage of the start battery (BAT1) below which the generator set is triggered for an automatic start. See chapter 9.2 to adjust this value. When no button is touched during 40 seconds, the display returns to the *initial level* automatically

3.4 Voltage of the second battery

Only displayed when a second battery is installed (refer to the appendix). It shows the actual battery voltage of the second battery (BAT2). When no button is touched during 40 seconds, the display returns to the *initial level* automatically

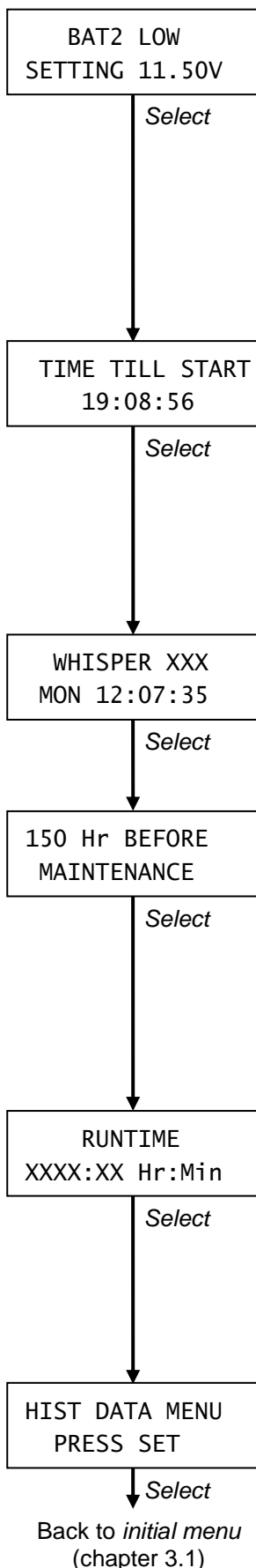

3.5 Trigger level autostart function (second battery)

Only displayed when a second battery is installed (refer to the installation manual) and when the *autostart function* is activated (see chapter 9). This value marks the voltage of the second battery (BAT2) below which the generator set is triggered for an automatic start. See chapter 9.3 to adjust this value. When no button is touched during 40 seconds, the display returns to the *initial level* automatically.

3.6 Time till start

Time till start shows a clock counting down. It represents the remaining time until the generator set will be started automatically. It is only displayed when the *interval mode* is activated (see chapter 10). When no button is touched during 40 seconds, the display returns to the *initial level* automatically.

3.7 Clock

The next level shows the actual time. Refer to chapter 11.2 for clock settings.

3.8 Time before maintenance

Time before maintenance shows the number of hours until the generator set needs to be serviced again. See also chapter 2.10. See chapter 8.8 to adjust the default time of this counter. When no button is touched during 40 seconds, the display returns to the *initial level* automatically.

3.9 Runtime

Runtime shows the cumulative runtime since the latest service maintenance inspection of the generator set. See chapter 12.1 to clear this counter after service. When no button is touched during 40 seconds, the display returns to the *initial level* automatically.

3.10 Historical data menu

From here you can enter the *historical data menu* by pressing *Set* shortly. See chapter 4 for a description of the *historical data menu*. Press *Select* shortly to return to the *initial level*. Also when no button is touched during 40 seconds, the display returns to the *initial level*.

4 MONITOR MENU

This chapter describes the functions of the *monitor menu*. This menu offers an actual status overview of the generator set and the batteries while the generator is running. It is therefore only available while the generator set is running: it is immediately accessible by pressing *Select* shortly. None of the displayed information can be modified.



Touch the *Select* button shortly to scroll through the levels as described below. Press *Set* shortly to return to the *initial level* (chapter 4.1)

W-SC3.5	
230V	10A

Single phase

W-SC3.5	
10.3A	120V 10.3A

Double phase

230V	230V	230V
9.8A	10A	9.9A

Three phase

↓ Select

230V	10.3A
52.2Hz	2.4kVA

Single phase

120V	10.3A
120V	10.4A

Double phase

↓ Select

WHISPER LOAD	
2.4kVA	70%

Single phase

L1:	1.2kVA
L2:	1.3kVA

Double phase

L1	L2	L3 (kVA)
2.2	2.4	2.3

Three phase

↓ Select

WHISPER RPM	
1500RPM	50.0Hz

↓ Select

4.1 Initial level

The *initial level* is shown after a successful start cycle. It shows:

- The identification of the Whisper generator model (not displayed at models with a three phase output voltage)
- The output voltage of the generator set,
- The current (Amps) supplied by the generator set.

4.2 Actual Voltage, Amps, Frequency and Load

Not displayed at models with a three phase output voltage. The next level shows the actual voltage, Amps, Frequency and load. With dual voltage versions (120V/240V) only the voltage and Amps of both phases are shown

4.3 Actual Load

At this level the load (kVA) connected to the generator set is displayed. Models with a single phase output voltage also show the percentage of the load related to the nominal load of the generator set.

This percentage is shown by the *load bar* as well

4.4 RPM and frequency

Shows the actual number of revolutions and the AC-frequency.

When no button is touched during 40 seconds, the display returns to the *initial level* automatically

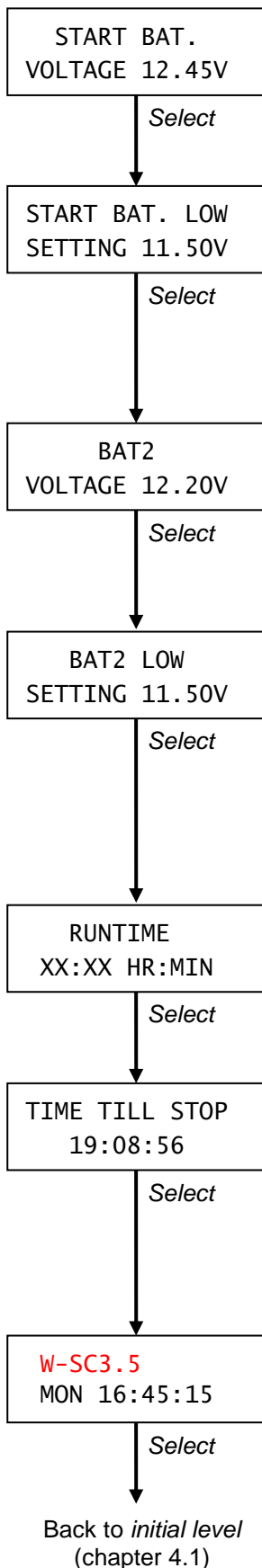

4.5 Start battery voltage

Actual voltage of the generator's start battery (BAT1). When no button is touched during 40 seconds, the display returns to the *initial level* automatically

4.6 Trigger level autostart function (start battery)

Only displayed when the *autostart function* is activated (see chapter 9). This value marks the voltage of the start battery (BAT1) below which the generator set is triggered for an automatic start. See chapter 9.2 to adjust this value. When no button is touched during 40 seconds, the display returns to the *initial level* automatically.

4.7 Second battery voltage

Only displayed when a second battery is installed (refer to the appendix). It shows the actual battery voltage of the second battery (BAT2). When no button is touched during 40 seconds, the display returns to the *initial level* automatically

4.8 Trigger level autostart function (second battery)

Only displayed when a second battery is installed (refer to the installation manual) and when the *autostart function* is activated (see chapter 9). This value marks the voltage of the second battery (BAT2) below which the generator set is triggered for an automatic start. When no button is touched during 40 seconds, the display returns to the *initial level* automatically.

4.9 Actual runtime

Actual runtime shows the runtime since the latest successful start cycle. When no button is touched during 40 seconds, the display returns to the *initial level* automatically.

4.10 Time till stop

Time till stop shows a clock counting down. It represents the time until the generator set will be stopped automatically. It is only displayed when the *interval mode* is activated (see chapter 10). When no button is touched during 40 seconds, the display returns to the *initial level* automatically.

4.11 Day and time

Here the actual day and time are displayed. To adjust the clock, see chapter 11.2. When no button is touched during 40 seconds, the display returns to the *initial level*.

5 HISTORICAL DATA MENU

To know the history of your generator set can be very useful. It will help you to check if the generator set needs major service maintenance. This can be done by reading the number of successful start attempts compared to the unsuccessful ones. It will also help you to decide whether the batteries need to be replaced. Therefore the deepest and the lowest average voltage can be shown as well as the number of low voltage hits triggered by the *autostart function*.

The *historical data menu* is only accessible when the generator set is not running. See chapter 3.10 to enter this menu.



Touch *Select* shortly to scroll through the levels as described below. When no button is touched during 40 seconds, the display returns to the *stand-by menu* (chapter 3) automatically.

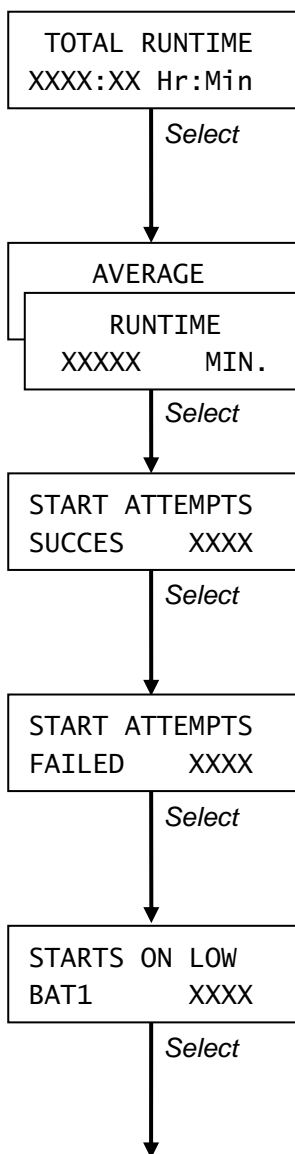

5.1 Total run time

This function displays the total time of successful generator runs. It is the hour counter of your generator set, which cannot be reset by the end-user.

5.2 Average runtime

Average runtime shows the *total run time* divided by the *number of successful start attempts*. See chapter 12.2 to reset this value.

5.3 Number of successful start attempts

This screen shows the total *number of successful start attempts*. Refer to chapter 12.2 if you want to reset this counter

5.4 Number of failed start attempts

This screen shows the *total number of failed start attempts*. Refer to chapter 12.2 if you want to reset this counter

5.5 Number of autostarts (start battery)

Only displayed when the *autostart function* is activated (see chapter 9). It shows the number of starts of the *autostart function* triggered by a low voltage of the start battery (BAT1). See chapter 9.2 and 9.6 to adjust this low voltage level (trigger level of the start battery). Refer to chapter 12.3 if you want to reset this counter

STARTS ON LOW
BAT2 XXXX

Select

DEEPEST VOLT.
BAT1 XX.XXV

Select

DEEP Vdc HITS
BAT1 XX

Select

LATEST WARNING
NO WARNING

Select

LATEST FAILURE
NO FAILURE

Select

Back to *total run time*
(chapter 5.1)

5.6 Number of autostarts (second battery)

Only displayed when the *autostart function* is activated (see chapter 9). It shows the number of starts of the *autostart function* triggered by a low voltage of the second battery (BAT2). See chapter 9.3 and 9.6 to adjust this low voltage level (trigger level of the second battery).

Refer to chapter 12.4 if you want to reset this counter

5.7 Deepest start battery voltage

This screen shows the lowest average voltage of the start battery (BAT1). Not shown when the *number of deep voltage hits* = 0. Refer to chapter 12.9 if you want to reset this value.

5.8 Number of deep voltage hits

Shows the number of times that the battery voltage dropped below the level of the *start battery low voltage warning* (BAT1). Every time the battery voltage drops below this level (see chapter 7.11) during 5 seconds, this counter is increased by 1.

A large number of deep voltage hits might indicate a too low battery capacity, an old battery that needs to be replaced or a defective battery charger.

Refer to chapter 12.9 if you want to reset this counter.

5.9 Latest warning

Latest warning shows the most recent warning that was detected by the control unit of the generator set during the last generator run. See chapter 13 for an overview of all possible warning codes.

5.10 Latest failure

This menu shows the cause of failure resulting in the last generator stop. See chapter 13 for an overview of the failure codes.

Press *Select* shortly to return to the *stand-by menu*. Also when no button is touched during 40 seconds, the display returns to the *stand-by menu*.

6 SELECT MENU

When the generator set is not running and access is allowed (see chapter 2.6), it is possible to enter the *select menu*. From the *select menu* several advanced submenus can be accessed.

From the *stand-by menu* (see chapter 3), hold *Select* pressed for approximately 3 seconds to get access to the *select menu*.

Press *Select* shortly to navigate through the *select menu*. Press *Set* shortly to enter the displayed submenu.

The submenus are:

- *Energy menu* (see chapter 7). This menu allows you to adjust the set points of the alarm functions.
- *Engine menu* (see chapter 8). It is used to adjust the *Digital Diesel Control* according to the generator's specifications.
- *Autostart menu* (see chapter 9). Adjustment of trigger points to start and stop the generator set automatically because of low battery voltage. (Restricted accessibility; see chapter 2.6)
- *Interval menu* (see chapter 10). Settings to run the generator set periodically. (Restricted accessibility; see chapter 2.6)
- The *display menu* (see chapter 11) is used to set the internal clock and to adjust the display according the user's specific requirements.
- *Service menu* (see chapter 12). Here you can reset and adjust several parameters after maintenance of your generator set.

From the *exit menu* you can return to the *stand-by menu* by pressing *Set* shortly. Also if none of the buttons was touched for 40 seconds, the *Digital Diesel Control* returns to the *stand-by menu*.

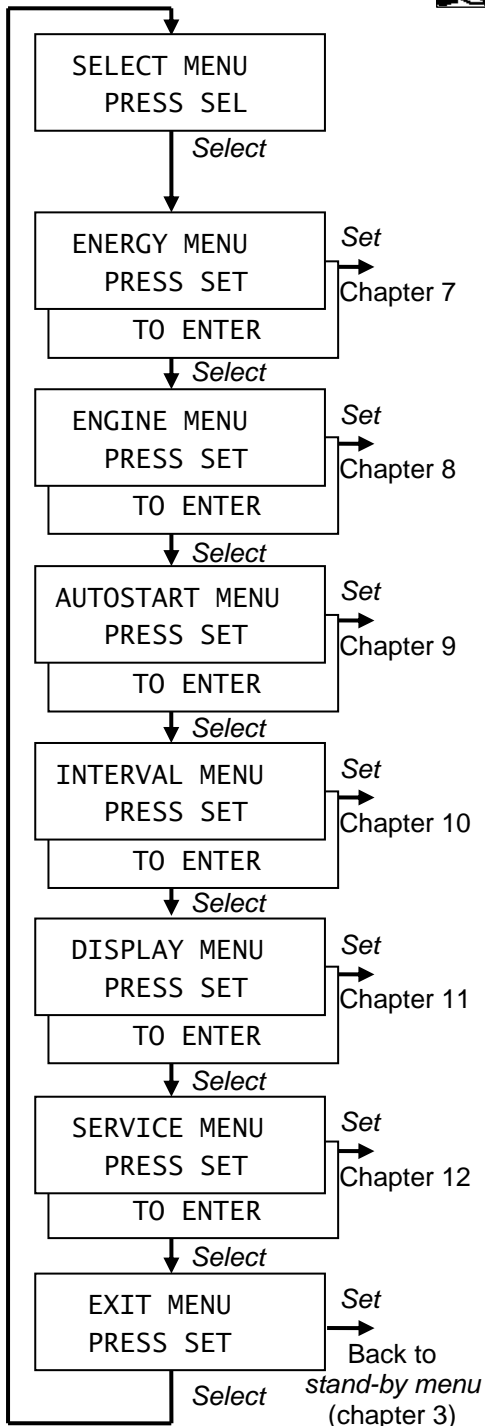

7 ENERGY MENU

At the *energy menu* you can:

- Adjust the parameters of the *alarm function*. If one of these parameters is out of range, the *alarm function* is activated. When activated, it can control an external relay or an audible alarm (refer to the installation manual)
- Adjust the *Digital Diesel Control* according to the nominal voltage of the *second battery* (BAT2);

The *energy menu* is only accessible when the generator set is not running. Refer to chapter 6 to gain access to this menu.



Touch *Select* shortly to scroll through the levels as described below. When no button is touched during 40 seconds, the display returns to the *stand-by menu* (chapter 3) automatically.



NOTE: If an arrow is displayed in the right part of the display, the direction of this arrow can be changed by holding *Select* pressed for three seconds. If the arrow is pointing downwards (↓) the displayed value can be decreased by pressing *Set* shortly. If the arrow is pointing upwards (↑) the value can be increased.

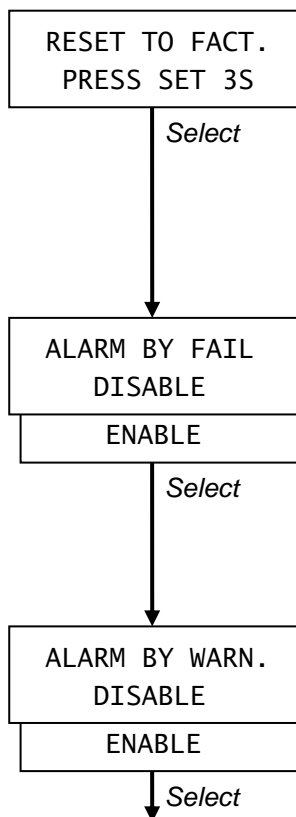

7.1 Reset to factory settings

The first screen allows you to reset all prior adjustments of the *energy menu* back to the factory defaults. Hold *Set* pressed for at least 3 seconds to reset all settings or press *Select* shortly to go to the next step.

7.2 Alarm triggered by a failure on/off

The *alarm function* can be triggered by a *failure*. When a *failure* is detected, the generator set is stopped automatically. See chapter 13 for an overview of all *failure codes*. Press *Set* shortly to enable/disable. Factory setting: disabled.

7.3 Alarm triggered by a warning on/off

The *alarm function* can also be triggered when a *warning* is issued. See chapter 13 for an overview of all *warning codes*. Press *Set* shortly to enable/disable. Factory setting: disabled.

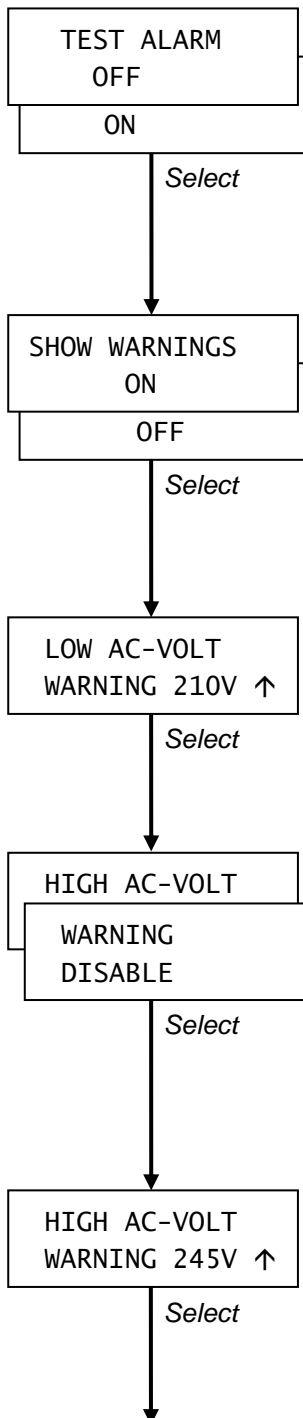

7.4 Test alarm output on/off

This function can be used to check the operation of the external relay. Press *Set* shortly to toggle the alarm function between “ON” and “OFF”. Beware: during normal operation of the *Digital Diesel Control* this function must be switched off!
Factory settings: OFF

7.5 Show warnings on/off

Press *Set* to enable or disable this function. If this function is disabled (OFF), the *warning codes* generated by the Digital Diesel Control will not be shown anymore at the LCD-display. See chapter 13 for an overview of all *warning codes*.
Factory settings: ON (*warning codes* are displayed)

7.6 Low AC-voltage warning

The *alarm function* will be triggered when the output voltage of the generator drops below this voltage
Factory setting: 210 V / 105 V (depending on the nominal voltage)

7.7 High AC-voltage warning enable/disable

Press *Set* to enable or disable this function. If this function is enabled (ENABLE), a warning is shown at the LCD display when the output voltage is higher than the setpoint for high voltage (see chapter 7.8). See chapter 13 for an overview of all *warning codes*.
Factory settings: DISABLE (High AC-voltage warning is not shown)

7.8 High AC-voltage warning

Only displayed when the *High AC-voltage warning* is enabled (see chapter 7.7) When the AC-voltage at the output of the generator rises above this setting, the *alarm function* will be triggered.
Factory settings: 128V / 245V / 253V (depending on the nominal output voltage of the generator)

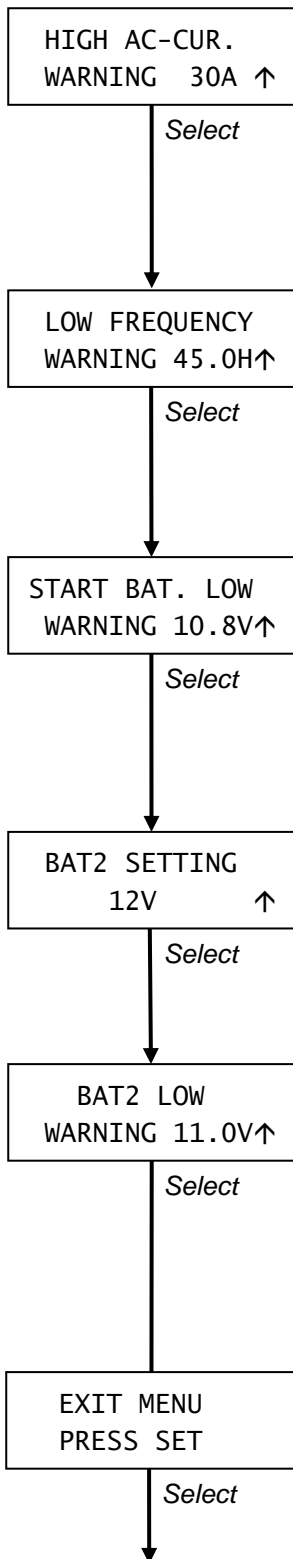

Back to reset to
factory settings
(chapter 7.1)

7.9 High AC-current warning

When the AC-current at the output of the generator rises above this setting, the *alarm function* will be triggered.

Factory setting: depending on the generator's nominal output current.

7.10 Low frequency warning

When the output frequency of the generator set drops below this value, the alarm function will be triggered.

Factory setting: 45 / 55Hz (depending on the nominal frequency 50 / 60Hz)

7.11 Start battery low voltage warning

The *alarm function* will be triggered when the voltage of the *start battery* (BAT1) drops below this value.

Factory setting: 10.8 / 21.6 V (depending on the nominal voltage of the start battery).

7.12 Nominal voltage of the second battery

Here you can select the nominal voltage of the second battery (BAT2) by pressing the *Set* button shortly. This value must be set to 0V if no second battery is connected to the *Digital Diesel Control*.

7.13 Second battery low voltage warning

Only displayed when a second battery is installed (refer to chapter 7.12). It marks the DC-voltage of the second battery (BAT2) below which the alarm function is triggered.

Factory setting: 11.0 / 22.0 V (depending on the nominal voltage of the second battery).

From the *exit menu* you can return to the *select menu* (chapter 6) by pressing *Set* shortly. If none of the buttons was touched for 40 seconds, the *Digital Diesel Control* returns to the *stand-by menu*.

8 ENGINE MENU

The *engine menu* is used to adjust the Digital Diesel Control according to the generator's specifications. Under normal circumstances adjustment of the parameters is not recommended. Refer to chapter 6 to gain access to this menu.



For each step below you need to finish within 40 seconds; otherwise the Digital Diesel Control returns to the *stand-by menu* again.

Press the *Select* button shortly to navigate through the *engine menu*. Press the *Set* button shortly to change a setting.

NOTE: If an arrow is displayed in the right part of the display, the direction of this arrow can be changed by holding *Select* pressed for three seconds. If the arrow is pointing downwards (↓) the displayed value can be decreased by pressing *Set* shortly. If the arrow is pointing upwards (↑) the value can be increased.

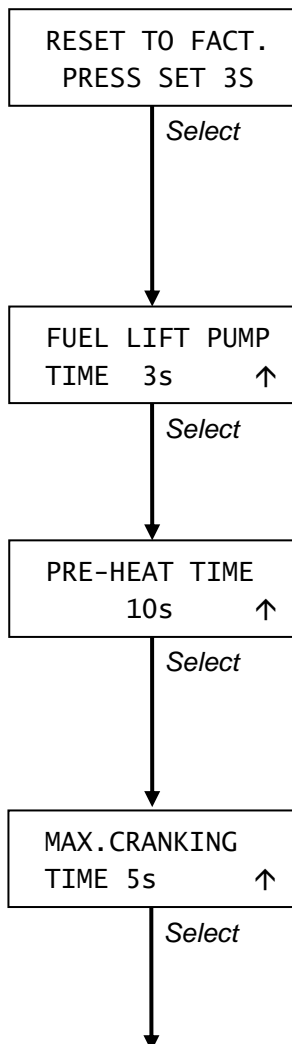

8.1 Reset to factory settings

The first screen allows you to reset all prior adjustments of the *engine menu* back to the factory defaults. Hold *Set* pressed for at least 3 seconds to reset all settings or press *Select* shortly to go to the next step.

8.2 Lift time of the fuel supply pump

This screen is used to adjust the operation time of the fuel lift pump prior to the cranking of the engine. Factory setting: 3 sec.

8.3 Pre heat time

For safe operation and longer life span of the generator set it is necessary to glow before starting the generator. Factory settings: 10 sec.

8.4 Maximum cranking time

Adjustment of the maximum run time of the cranking motor. Factory settings: 5 sec

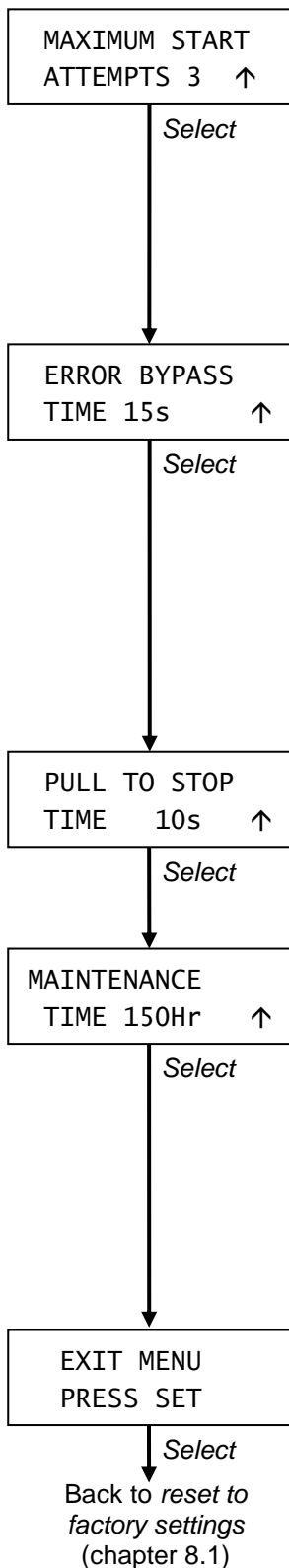

8.5 Maximum number of start attempts

This function allows the user to set the maximum number of start attempts. Example: When set to 3 and the generator is triggered to start, the Digital Diesel Control will try to start the generator set for another two times if the generator did not start after the first attempt. Factory setting: 3 attempts

8.6 Starting error by-pass time

If the generator set fails to start after a start attempt, the Digital Diesel Control tries to start the generator again (see paragraph 8.5). To check whether the start attempt was successful, the control unit on the generator measures the AC-output voltage of the generator set. This measurement is delayed to be sure the generator set is stable in operation.

Factory setting of the failure by-pass time: 15 sec.

8.7 Pull to stop time

Only available for **W-SC3.5** models.
Factory setting: 10 sec.

8.8 Set maintenance time

At normal circumstances the generator set needs to be serviced for the first time after 50 running hours (fixed value), and then after every 150hrs. However, in some cases a different maintenance interval should be applied. Refer to the user's manual of the generator for detailed information.

Factory settings: 150 hours.

From the *exit menu* you can return to the *select menu* (chapter 6) by pressing *Set* shortly. If none of the buttons was touched for 40 seconds, the *Digital Diesel Control* returns to the *stand-by menu*.

9 AUTOSTART MENU

The *Digital Diesel Control* offers an automatic generator start/stop function, triggered by the battery voltage. When the battery voltage is too low, the generator set can be started automatically in order to recharge the batteries. The generator set is stopped again after the batteries were charged.

In addition a *silent period* can be set to avoid an unintended generator run during night time. During this period, “silent period” is displayed at the *initial level* of the *stand-by menu* (see chapter 3). This means that the generator set will not be started automatically.

At the *autostart menu* you can adjust the settings of the *autostart function*.



Before using the *autostart function* make sure:

- that access to the *autostart menu* is allowed at the *set up menu* (see appendix)
- the internal clock is set to the correct time (see chapter 11.2), if you intend to use the *silent period*.
- the *lock mode* (see chapter 11.4) is switched off before programming.
- the generator is ready to operate. Among other things, this means that enough cooling liquid, oil and gasoline are available and all valves are opened (refer to the operating manual of the generator set).



NOTES:

- The *autostart function* will fail to start the generator set when *maintenance time* has elapsed. However, when the *maintenance time* elapses during a generator run, the generator will not stop until the *Minimum runtime* (chapter 9.6) has elapsed.
- You can start or stop the generator set manually at any time (also during the *silent period!*) by pressing *Start / Stop* shortly.
- When the generator set failed to start or was stopped because of a failure, the *autostart function* will be disabled automatically. This means that the generator start can not be triggered by a low battery voltage again.
- When the *autostart function* is activated, two blinking stars (×) are shown on the display at the *initial level* of the *stand-by menu*.
- If during programming an arrow is displayed in the right part of the display, the direction of this arrow can be changed by holding *Select* pressed for three seconds. If the arrow is pointing downwards (↓) the displayed value can be decreased by pressing *Set* shortly. If the arrow is pointing upwards (↑) the value can be increased.

Refer to chapter 6 to gain access to the *autostart menu*.

Press the *Select* button shortly to navigate through the *autostart menu*. Press the *Set* button shortly to change a setting.

For each step below you need to finish within 40 seconds; otherwise the *Digital Diesel Control* returns to the *stand-by menu* again.

CAUTION!

Whisper Power cannot be held responsible for any damage caused by the unattended running of the generator set in the *autostart function*

WARNING!

When working on the electrical installation make sure that the generator cannot start automatically. First remove the 3 Amps fuse from the local control panel and then disconnect the plus poles of the batteries.

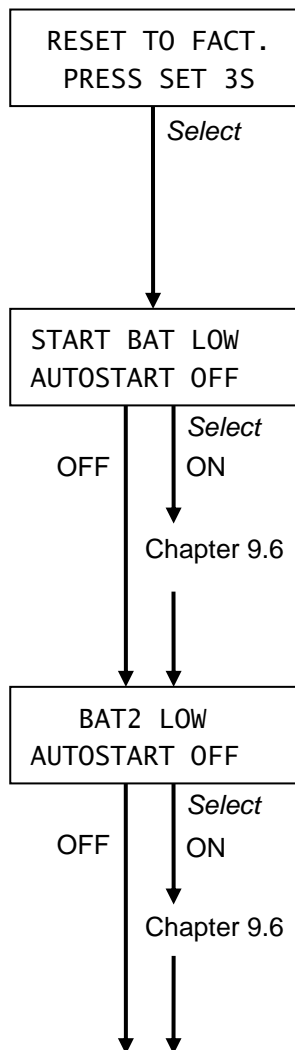

9.1 Reset to factory settings

The first screen allows you to reset all prior adjustments of the *autostart menu* back to the factory defaults. Hold *Set* pressed for at least 3 seconds to reset all settings or press *Select* shortly to go to the next step.

9.2 Autostart - Start battery on/off

Press *Set* shortly to enable / disable (ON / OFF) the *autostart function* triggered by the start battery (BAT1).

- When switched to ON, press *Select* shortly to adjust the trigger points of the *autostart function*; continue with chapter 9.6.
- When switched to OFF, press *Select* shortly to continue to the next step

9.3 Autostart - Second battery on/off

Press *Set* shortly to enable / disable (ON / OFF) the *autostart function* triggered by the second battery (BAT2). This function is only displayed when a second battery was installed.

- When switched to ON, press *Select* shortly to adjust the trigger points of the *autostart function*; continue with chapter 9.6.
- When switched to OFF, press *Select* shortly to continue to the next step

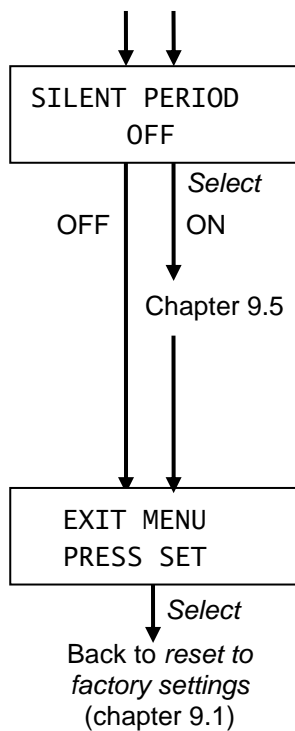

9.4 Silent Period on/off

Press *Set* shortly to enable / disable (ON / OFF) the *silent period*. If the silent period is activated (ON), the generator set will not be started automatically during the specified period.

- When switched to ON, press *Select* shortly to specify the time frame of the silent period; continue with chapter 9.5.
- When switched to OFF, press *Select* shortly to continue to the next step

From the *exit menu* you can return to the *select menu* (chapter 6) by pressing *Set* shortly. If none of the buttons was touched for 40 seconds, the *Digital Diesel Control* returns to the *stand-by menu*.

9.5 Adjustment of the silent period

The *silent period* is the daily time period that the generator set should not be started automatically by the *autostart function*. You can use this function to avoid an unintended generator run during night time.

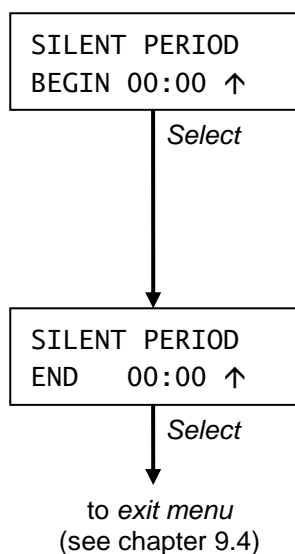

Silent period begin

Hours blinking: press *Set* several times to adjust the hours of the begin time. Then press *Select* shortly.

Minutes blinking: press *Set* several times to adjust the minutes of the begin time. Then press *Select* shortly

Silent period end

Hours blinking: press *Set* several times to adjust the hours of the end time. Then press *Select* shortly

Minutes blinking: press *Set* several times to adjust the minutes of the end time.

Then press *Select* shortly. Return to chapter 9.4.

9.6 Adjustment of the autostart trigger points

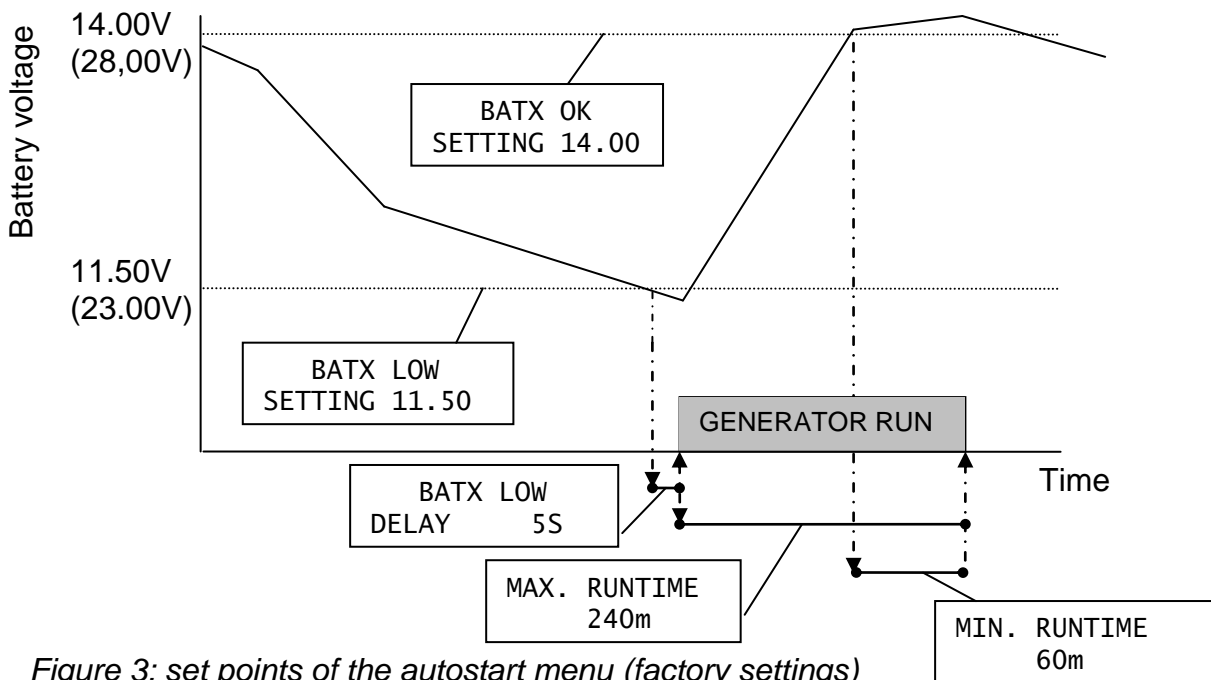

Figure 3: set points of the autostart menu (factory settings)

BATX LOW
SETTING 11.50↑

Select

BATX LOW
DELAY 5S ↑

Select

BATX OK
SETTING 14.00↑

Select

MIN. RUNTIME
60m ↑

Select

MAX. RUNTIME
240m ↑

Select

Trigger level autostart function

The first parameter marks the battery voltage below which the autostart function is triggered. Factory setting: 11.50V / 23.00V

Delay time

The *battery low delay* prevents the *autostart function* being triggered during a small low voltage drop. Factory setting: 5 sec.

Battery OK setting

This parameter marks the voltage above which the battery is considered to be fully charged. It is the trigger to start the *Minimum runtime*. Factory setting: 14.00 / 28.00V

Minimum runtime

This is the minimum time that the generator set will keep running after the battery voltage reached the *battery OK setting*. Factory setting: 60 minutes.

Maximum runtime

To avoid an incessant generator run caused by the fact that the battery voltage doesn't reach the *battery OK setting*, a maximum runtime can be set. Factory setting: 240 minutes.

10 INTERVAL MENU

With the *interval menu* you can programme the *interval mode*: a timer to start and stop the generator set at any desired moment, like you would programme a VCR.



Before using the *interval mode* make sure:

- that access to *interval menu* is allowed at the *set up menu* (see appendix).
- the internal clock is set to the correct time (see chapter 11.2).
- the *lock mode* (see chapter 11.4) is switched off before programming the *interval menu*.
- the generator set is ready to operate. Among other things, this means that enough cooling liquid, oil and gasoline are available and all valves are opened (refer to the operating manual of the generator set).



NOTES:

- The generator set will fail to start when the *maintenance time* has elapsed. However, when the *maintenance time* elapses during a generator run, the generator set will not stop until the *interval end time* is reached.
- You can stop the generator set at any time by pressing *Stop* shortly.
- When the generator set failed to start or was stopped because of a failure, the *interval mode* will be cancelled automatically. This means that the generator set will not be started automatically again.
- When the *interval mode* is activated, at the *initial level* of the *stand-by menu* two blinking stars (✖) are shown on the display and the *time till start* function is available at the *stand-by menu* (chapter 3.6).
- If during programming an arrow is displayed in the right part of the display, the direction of this arrow can be changed by holding *Select* pressed for three seconds. If the arrow is pointing downwards (↓) the displayed value can be decreased by pressing *Set* shortly. If the arrow is pointing upwards (↑) the value can be increased.

Refer to chapter 6 to gain access to the *interval menu*.

Press *Select* shortly to navigate through the *interval menu*. Press *Set* shortly to change a setting.

For each step below you need to finish within 40 seconds; otherwise the *Digital Diesel Control* returns to the *stand-by menu* again.



CAUTION!

Whisper Power cannot be held responsible for any damage caused by the unattended running of the generator set in the *interval mode*



WARNING!

When working on the electrical installation make sure that the generator cannot start automatically. First remove the 3 Amps fuse from the local control panel and then disconnect the plus poles of the batteries.

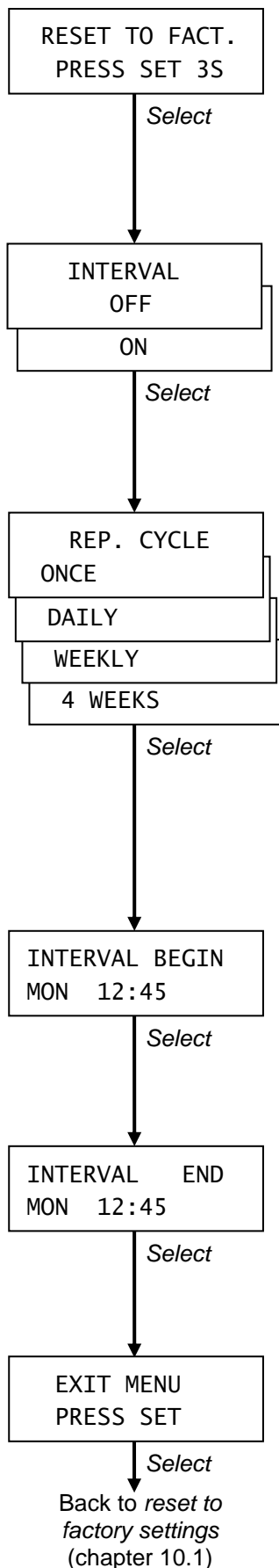

10.1 Reset to factory settings

The first screen allows you to reset all prior adjustments of the *interval menu* back to the factory defaults. Hold *Set* pressed for at least 3 seconds to reset all settings or press *Select* shortly to go to the next step.

10.2 Interval Auto start ON/OFF

Press *Set* shortly to enable / disable (ON / OFF) the interval mode.

Then press *Select* shortly to go to the next step. When switched to OFF, you will go to the *exit menu* immediately
Factory settings: OFF (no programme)

10.3 Repeat cycle

Press *Set* shortly to change the desired repeat cycle mode:

- *Once*: the generator will be started and stopped only once.
- *Daily*: the generator set will be started and stopped every day at the same time.
- *Weekly*: the generator set will be started and stopped once a week.
- *4 weeks*: the generator set will be started and stopped every four weeks.

Press *Select* to go to the next step

10.4 Interval begin

First choose the start day (day is blinking) by pressing *Set* shortly. Then press *Select* shortly to store the displayed day. Repeat this for the hours and minutes.

10.5 Interval end

In the same way the end time of the interval can be adjusted (NOTE: the day cannot be specified here; an interval can never last more than 23 hours and 59 minutes)

From the *exit menu* you can return to the *select menu* (chapter 6) by pressing *Set* shortly. If none of the buttons was touched for 40 seconds, the *Digital Diesel Control* returns to the *stand-by menu*.

11 DISPLAY MENU

The *display menu* is used to adjust the internal clock and to set the display according to the user's specific requirements.

Refer to chapter 6 to gain access to this menu.



For each step below you need to finish within 40 seconds; otherwise the *Digital Diesel Control* returns to the *stand-by menu* again.

Press the *Select* button shortly to navigate through the *Display menu*. Press the *Set* button shortly to change a setting.

NOTE: If an arrow is displayed in the right part of the display, the direction of this arrow can be changed by holding *Select* pressed for three seconds. If the arrow is pointing downwards (↓) the displayed value can be decreased by pressing *Set* shortly. If the arrow is pointing upwards (↑) the value can be increased.

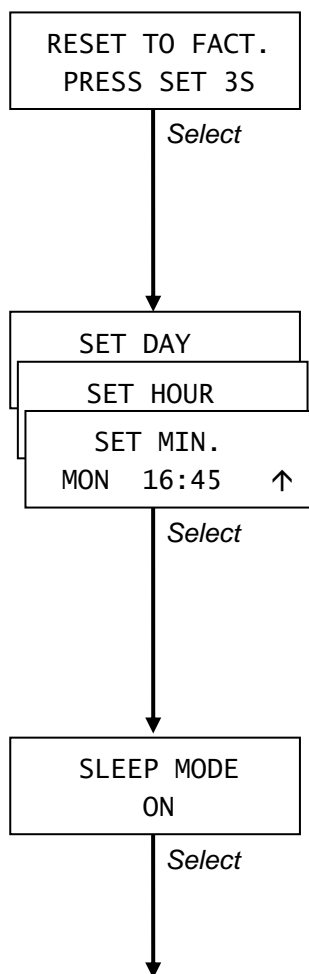

11.1 Reset to factory settings

The first screen allows you to reset all prior adjustments of the *display menu* back to the factory defaults.

Hold *Set* pressed for at least 3 seconds to reset all settings or press *Select* shortly to go to the next step.

11.2 Set clock

To adjust the clock:

- Day is blinking: choose the day by pressing *Set* shortly. Then press *Select* shortly to continue.
- Hour is blinking: adjust the hour (24hr clock) by pressing *Set* shortly. Then press *Select* shortly to continue.
- Minute is blinking: adjust the minutes by pressing *Set* shortly. Then press *Select* shortly to continue.

11.3 Sleep mode

If the *sleep mode* is enabled (ON) the backlight of the display switches off automatically if the buttons are not touched for 4 minutes. As soon as one of the buttons is touched, the display's backlight will be lit again for an easy reading of the display.

Press *Set* to toggle the *sleep mode*.

Factory setting: ON

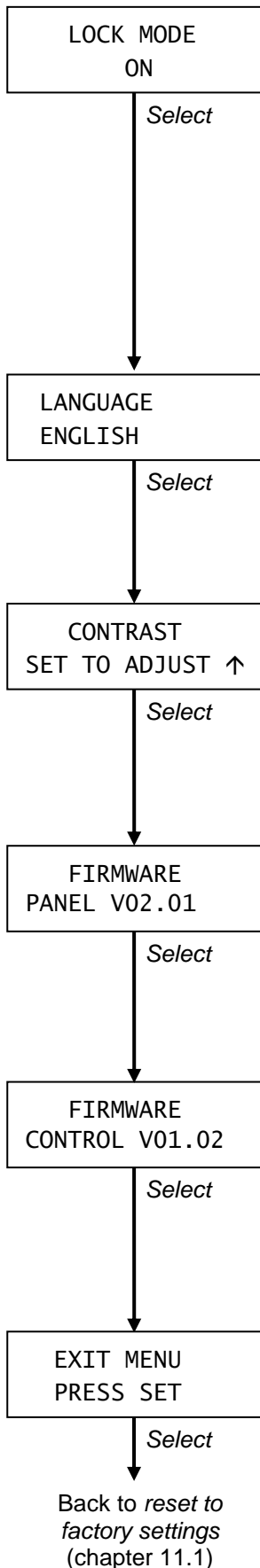

11.4 Lock mode

To protect the *Digital Diesel Control* against unintended adjustment of the variable set points, the *lock mode* is activated every time you leave a (sub)menu. When activated, critical settings cannot be changed when the *lock-mode symbol* (✖) is shown on the right upper corner of the display. Press *Set* to toggle the lock mode. Factory setting: ON

11.5 Language setting

Press *Set* to choose the desired language. Factory setting: ENGLISH. Then press *Select* to continue.

11.6 Contrast

The contrast of the display may change due to ambient conditions. Press *Set* to adjust the display's contrast. Then press *Select* to continue.

11.7 Firmware Panel

Firmware Panel shows the software version that is installed in the microprocessor of the panel. This value can not be changed; for installer's reference only.

11.8 Firmware Control

Firmware Control shows the software version that is installed in the microprocessor of the generator's control unit. This value can not be changed; for installer's reference only.

From the *exit menu* you can return to the *select menu* (chapter 6) by pressing *Set* shortly. If none of the buttons was touched for 40 seconds, the *Digital Diesel Control* returns to the *stand-by menu*.

12 SERVICE MENU

At the *service menu* you can reset several counters or adjust several set-points after service maintenance of your generator set.
Refer to chapter 6 to gain access to this menu.



Touch *Select* shortly to scroll through the levels as described below. When no button is touched during 40 seconds, the display returns to the *stand-by menu* (chapter 3) automatically.

NOTE: If an arrow is displayed in the right part of the display, the direction of this arrow can be changed by holding *Select* pressed for three seconds.
If the arrow is pointing downwards (↓) the displayed value can be decreased by pressing *Set* shortly. If the arrow is pointing upwards (↑) the value can be increased.

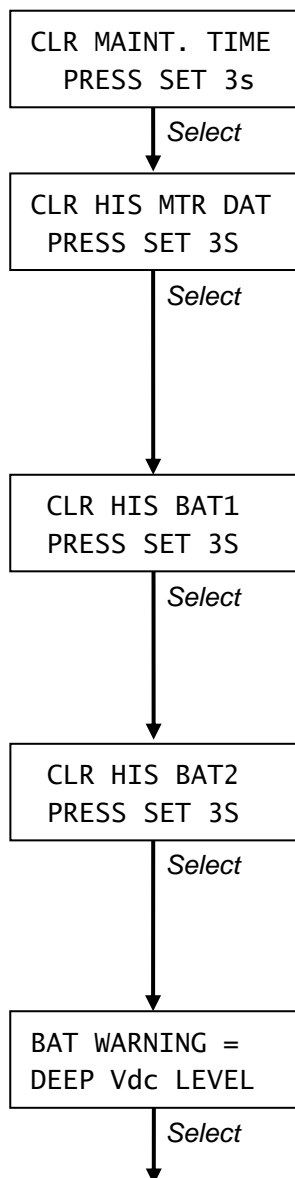

12.1 Clear maintenance time

Hold *Set* pressed for three seconds to clear the maintenance time counter after service.

12.2 Clear number of start attempts

The first screen allows you to clear the *average runtime* (see chapter 5.2), the *total number of failed start attempts* (see chapter 5.3) and the *total number of successful start attempts* (see chapter 5.4).

Hold *Set* pressed for at least 3 seconds to clear these counters or press *Select* shortly to go to the next step.

12.3 Clear number of autostarts (start battery)

Only displayed when the *autostart function* is activated. See chapter 5.5. Hold *Set* pressed for at least 3 seconds to clear the number of starts of the *autostart function* triggered by a low voltage of the start battery (BAT1) or press *Select* shortly to go to the next step.

12.4 Clear number of autostarts (second battery)

Only displayed when the *autostart function* is activated. See chapter 5.6. Hold *Set* pressed for at least 3 seconds to clear the number of starts of the *autostart function* triggered by a low voltage of the second battery (BAT2) or press *Select* shortly to go to the next step.

12.5 Latest battery warning

This screen shows the most recent battery warning that was issued by the *alarm function*. (see chapters 7.11 and 7.13). It will help you to decide whether the parameters of the *alarm function* should be adjusted. It can also be used to decide whether the batteries need to be replaced.

See chapter 13 for an overview of all *warning codes*.

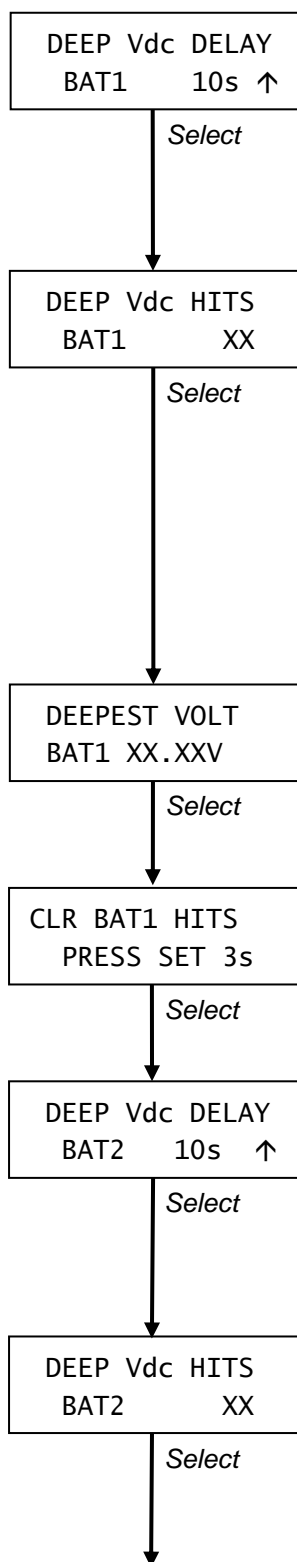

12.6 Alarm function delay time (start battery)

This level is used to set the delay time of the *alarm function* triggered by a low voltage of the start battery (BAT1). See chapter 7.11. This delay prevents the *alarm function* being activated during a small dip in the battery voltage.

Factory setting: 10 sec.

12.7 Number of deep voltage hits (start battery)

Shows the number of times that the battery voltage of the start battery dropped below the level of the *start battery low voltage warning* (BAT1) (read only). Every time the battery voltage drops below this level during 5 seconds, this counter is increased by 1. A large number of deep voltage hits might indicate a too low battery capacity, an old battery that needs to be replaced or a defective battery charger.

See chapter 7.11 to adjust the level of the *start battery low voltage warning*.

12.8 Deepest voltage of the start battery

This screen shows the lowest average voltage of the start battery (BAT1). A lowering value might indicate an old battery that needs to be replaced.

12.9 Clear deep voltage hits (start battery)

Hold *Set* pressed for at least 3 seconds to clear the counter for the *number of deep voltage hits (start battery)* (see chapter 12.7) and the *deepest voltage of the start battery* (see chapter 12.8).

12.10 Alarm function delay time (second battery)

This level is used to set the delay time of the *alarm function* triggered by a low voltage of the second battery (BAT2). See chapter 7.13. This delay prevents the *alarm function* being activated during a small dip in the battery voltage.

Factory setting: 10 sec.

12.11 Number of deep voltage hits (second battery)

Shows the number of times that the battery voltage of the start battery dropped below the level of the *second battery low voltage warning* (BAT2) (read only). Every time the battery voltage drops below this level during 5 seconds, this counter is increased by 1. A large number of deep voltage hits might indicate a too low battery capacity, an old battery that needs to be replaced or a defective battery charger.

See chapter 7.13 to adjust the level of the *second battery low voltage warning*.

DEEPEST VOLT
BAT2 XX.XV

Select

CLR BAT2 HITS
PRESS SET 3s

Select

SERVICE START
PRESS SET

Select

EXIT MENU
PRESS SET

Select

Back to *clear
maintenance time*
(chapter 12.1)

12.12 Deepest voltage of the second battery

Only displayed if the number of deep voltage hits (second battery) >0. This screen shows the lowest average voltage of the second battery (BAT2). A lowering value might indicate an old battery that needs to be replaced.

12.13 Clear deep voltage hits (second battery)

Hold Set pressed for at least 3 seconds to clear the counter for the *number of deep voltage hits (second battery)* (see chapter 12.11) and the *deepest voltage of the second battery* (see chapter 12.12).

12.14 Service start

Under normal circumstances, when the Generator AC output voltage or frequency is out of range, the generator set is stopped automatically within a few seconds. This is to protect the connected load.

However when the generator set is serviced, this automatic stop may be undesirable. In those cases a *service start* can be applied. With this *service start* the generator set will run for two minutes to make it possible to carry out measurements by service engineers

CAUTION: Too high or too low voltages may appear on the generator output. This may cause serious damage to the connected AC-load. Therefore appropriate measures must be taken, e.g. disconnect all loads from the generator. For this reason use of the service start may only be executed by trained technical engineers.

From the *exit menu* you can return to the *select menu* (chapter 6) by pressing *Set* shortly. If none of the buttons was touched for 40 seconds, the *Digital Diesel Control* returns to the *stand-by menu*.

13 WARNING AND FAILURE CODES

The tables below explain the *warning codes* and *failure codes*. Refer to the trouble shooting chapter at the user's manual of the generator set. Consult an installer, if you cannot solve the problem by means of this user's manual.

A *warning code* is displayed when one of the settings of the *energy menu* (chapter 7) is out of range.

Warning code	Problem
NO WARNING	None (no warning was detected)
ALTERNATOR	No battery charging voltage.
LOW STARTBAT	Voltage of the start battery (BAT1) is below setting (chapter 7.11)
NO BAT2	No second battery detected or voltage is below 5V while nominal voltage is set at 12V or 24V (chapter 7.10; check connections/ fuses/ polarity of the second battery)
LOW BAT2	Voltage of the second battery (BAT2) is below setting (chapter 7.13).
FREQUENCY	Output frequency of the generator is below setting (chapter 7.10)
AC-1 VOLTAGE	Generator AC output voltage (phase 1, 2 or 3) is too low (see chapter 7.6 for setting of threshold value) or too high (chapter 7.7 and 7.8)
AC-2 VOLTAGE	
AC-3 VOLTAGE	
HIGH CURRENT 1	Output current of the generator is above setting (phase 1, 2 or 3) (see chapter 7.9)
HIGH CURRENT 2	
HIGH CURRENT 3	
COMMUNICATION	Communication error between the panel and the generator set. Check the cable connection between the panel and the control unit.
CHARGER TEMP	Temperature of charger too high (sc-3 models)

A *failure code* is displayed when a hardware failure at the generator set is detected.

Failure code	Problem
NO FAILURE	None (no failure was detected)
COMMUNICATION	Communication error between the panel and the generator
LOW BAT1	Starter battery voltage (BAT1) too low
ALTERNATOR	No battery charging voltage.
EXHAUST TEMP	Exhaust temperature is too high (marine generators only)
AC-ALTERN. TEMP	AC-alternator temperature is too high (generators for mobile applications only)
WATER TEMP	Coolant temperature is too high.
OIL PRESSURE	Oil pressure failure
AC-1 VOLTAGE	Generator AC output voltage is out of range (phase 1, 2 or 3) (<100V or > 125V / <205V or >253V, depending on the nominal output voltage)
AC-2 VOLTAGE	
AC-3 VOLTAGE	
HIGH CURRENT	Generator is in overload
FREQUENCY	Output frequency of the generator is <45Hz or >55Hz (50Hz models) or <55Hz or >65Hz (60Hz models)

14 TECHNICAL DATA

Model	Digital Diesel Control – version 1		
Article number	70 40 3150		
Function of the product:	Monitoring and remote control instrument for a Whisper generator set.		
Delivery:	Included with the supply of a Whisper generator set		
Manufacturer	Whisper Power Drachten, the Netherlands		
Supply voltage	Internally powered by the generator control unit.		
Connection 2nd battery:	Optional, input voltage range: 0-40V		
Operating temperature:	0 to 45 °C	Emission:	EN 50081-1
Storage temperature:	-20 to 70 °C	Immunity:	EN 50082-2
CE conformity:	yes	LV directive:	73/23/EEG
EMC directive:	89/336/EEG	Safety:	EN60950

APPENDIX

Wrong operation of the *Digital Diesel Control* may lead to hazardous situations. Therefore the availability of certain functions and accessibility to specific menus can be restricted or extended at the *set-up menu*.

Instructions that are stated in this appendix may only be carried out by trained technical engineers!

SET-UP MENU

Follow the procedure below to gain access to the *set-up menu*.



IMPORTANT: Perform these steps only if you want to:

- change the Whisper generator model type, or
- change the accessibility to the *select menu*, or
- change the accessibility to the *autostart menu*, or
- change the accessibility to the *interval menu*, or
- add an offset to the measured values that are displayed.



If none of the buttons was touched for 40 seconds, the *Digital Diesel Control* will go to the *stand-by menu* without saving any of the settings. If this occurs unintended, you have to repeat the whole procedure again.

Keep the *Select* and the *Set* buttons pressed simultaneously while you insert the modular connector of the communication cable into the modular socket of the panel. You will enter the *set-up menu*. See below. Touch *Select* shortly to scroll through the levels as described below.

RESET TO FACT.
PRESS SET 3S

Select

CHANGE MODEL
PRESS SET 3S

Select

AUTOMATIC MODE
SWITCH OFF WHEN

MAINTENANCE
IS NEEDED

Select

Reset to factory settings

This screen allows you to reset all prior adjustments of the *set-up menu* back to the factory defaults.

Hold *Set* pressed for at least 3 seconds to reset all previous settings or press *Select* shortly to go to the next step.

Change model type

The Digital Diesel Control recognizes the generator model automatically. If it fails to do so, you can select the model type here. To change the model type, hold *Set* pressed for at least 3 seconds. Then press *Select* shortly to scroll to the corresponding model type, followed by *Set* to store. Now "SEND GENTYPE PRESS SET 3S" is displayed. Press *Set* for 3 seconds to confirm the new setting or press *Select* to cancel

Override maintenance blocking

By default the *autostart function* and *interval mode* are blocked to start the generator set when *maintenance time* has elapsed. Press *Set* if you want to override this blocking (=ON)

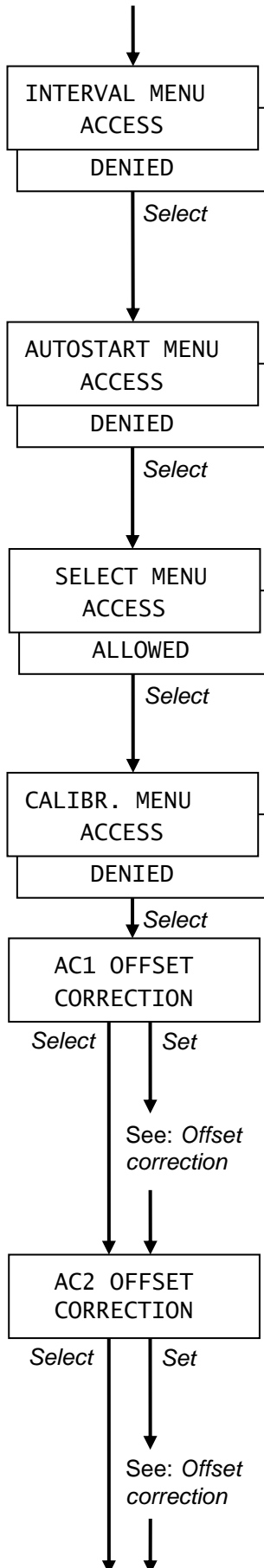

Access to interval menu denied / allowed

With the *interval menu* you can programme the *interval mode*: a timer to start and stop the generator set at any desired moment. See chapter 10 for programming functions.

Press *Set* to allow accessibility to the *interval menu*.

Factory setting: denied.

Access to autostart menu denied / allowed

The *autostart menu* allows you to start the generator, triggered by a low battery voltage. See chapter 9.

Press *Set* to allow accessibility to the *autostart menu*.

Factory setting: denied.

Access to the select menu

From the *select menu* several advanced submenus can be accessed. See chapter 6 for explanation. Press *Set* to disable the accessibility to the *select menu*.

Factory setting: access allowed

Access to the calibration menu

To be used by the manufacturer only. NEVER change this setting.

Press *Select* shortly to continue.

AC1 offset correction

If necessary, you can add a positive or negative offset value to the measured AC voltage (U_{ac1}) and AC current (I_{ac1}).

With dual voltage versions (120V/240V) AC1 is the first phase.

Factory settings: no offset.

Press *Set* shortly to change the offset (see *Offset correction* below) or press *Select* shortly to go to the next step.

AC2 offset correction

Only available for *dual voltage* versions (120/240V). Same as *AC1 offset correction*, but for the second phase (AC voltage: U_{ac2} ; AC current: I_{ac1}).

Factory settings: no offset.

Press *Set* shortly to change the offset (see *Offset correction* below) or press *Select* shortly to go to the next step.

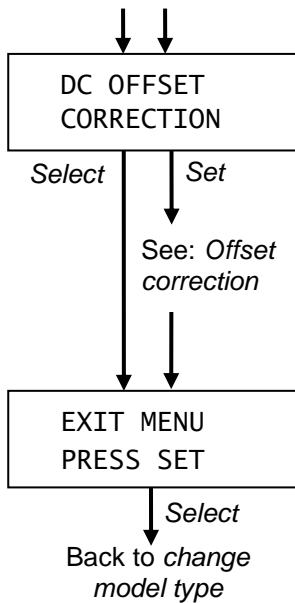

DC offset correction

If necessary you can add positive or negative offset values to the measured DC voltage (Volt DC) of the *start battery* (BAT1) and the *second battery* (BAT2).

Factory settings: no offset.

Press *Set* shortly to change the offset (see *Offset correction* below) or press *Select* shortly to go to the next step.

At the *exit menu* press *Set* shortly to save all adjustments at the *set-up menu* and to go to the *stand-by menu* (see chapter 3)

If none of the buttons was touched for 40 seconds, the *Digital Diesel Control* will go to the *stand-by menu* without saving any of the adjustments.

Press *Select* to return to *reset to factory settings*

Offset correction

The *Digital Diesel Control* offers you the possibility to add a positive or negative offset to the displayed values.



NOTE: At the *offset correction* an arrow is displayed in the right part of the display. The direction of this arrow can be changed by holding *Select* pressed for three seconds.

If the arrow is pointing downwards (↓) the displayed value can be decreased by pressing *Set* shortly. If the arrow is pointing upwards (↑) the value can be increased.

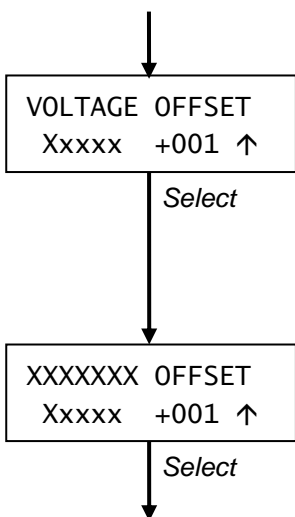

AC1 OFFSET: AC-voltage U_{ac1} , in steps of 1 Volt AC.

AC2 OFFSET: AC-voltage U_{ac2} , in steps of 1 Volt AC.

DC OFFSET: Start battery (BAT1) voltage, in steps of 0.01V.

Press *Select* shortly after adjusting this offset value.

AC1 OFFSET: AC-amps I_{ac1} , in steps of 0.01 Amp AC.

AC2 OFFSET: AC-amps I_{ac2} , in steps of 0.01 Amp AC

DC OFFSET: Second battery (BAT2) voltage, in steps of 0.01V

Press *Select* shortly after adjusting this offset value. You will return to the *set-up menu*.

Back to *set-up menu*

SECOND BATTERY

If a second battery is connected to the *Digital Diesel Control*, refer to chapter 7.12 of this manual to select the nominal voltage of this battery

INDEX

	Page		Page
Alarm, external relay	20, 21	Run time, total	17
Autostart function / menu	9, 19, 25	Second battery (BAT2)	13, 16, 22
Clock	14, 16, 31	Select button	9
Display menu	19, 31	Select menu	19
Display, LCD	8	Service menu	19, 33
Energy menu	19, 20	Set button	9
Engine menu	19, 23	Silent period	27
Failure	11, 18, 36	Sleep mode	31
Firmware	32	Specifications	36
Historical data menu	14, 17	Stand-by menu	13
Interval mode / menu	19, 29, 37	Start battery (BAT1)	13, 16
Load bar	8	Start button	8
Lock mode	9, 32	Start cycle	11
Maintenance, generator-	12, 33	Stop button	8
Monitor menu	15	Stop cycle	12
Run time, actual	16	Time before maintenance	12, 14, 24
Run time, average	17	Warning	18, 20, 36

TROUBLE SHOOTING

Problem	Possible cause
Wrong language is shown	Change language setting (see chapter 11.5 or refer to the Quick reference guide)
The <i>select menu</i> is not shown	Accessibility to this menu is denied (see chapter 2.6)
I cannot access the <i>autostart menu</i>	Accessibility to this menu is denied (see chapter 2.6)
I cannot access the <i>interval menu</i>	Accessibility to this menu is denied (see chapter 2.6)
I can not change a setting	<i>Lock mode</i> is activated (see chapter 2.7)
Generator is not started automatically (autostart function)	Wrong settings (see chapter 9) <i>Maintenance time</i> has elapsed (see page 25) <i>Autostart function</i> is disabled caused by a <i>failure</i> (see page 25) <i>Silent period</i> is active (see chapter 9.4)
Generator is not started automatically (interval mode)	Wrong settings (see chapter 10) <i>Maintenance time</i> has elapsed (see page 29) <i>Interval mode</i> is disabled caused by a <i>failure</i> (see page 29) Wrong settings of the internal clock (see chapter 11.2)
A "WARNING" is displayed	Parameters set at the <i>energy menu</i> are out of range (chapter 7 and 13)
A "FAILURE" is displayed	Generator set is stopped because of a <i>hardware failure</i> (chapter 13)