



USER'S MANUAL

W-GV/2, W-GV/3, W-GV 8 and W-GV 10 genverters for mobile use



Art.nr. 40200981

WHISPERPOWER BV
Kelvinlaan 82
9207 JB Drachten
Netherlands
Tel.: +31-512-571550
Fax.: +31-512-571599
www.whisperpower.com



CONTENTS

1	INTRODUCTION	4
1.1	General	4
1.2	Service and maintenance	4
1.3	Guarantee.....	4
1.4	Liability	5
1.5	Identification	5
1.5.1	General	5
1.5.2	Identification plate.....	5
2	GENERAL INFORMATION	6
2.1	Safety.....	6
2.1.1	General	6
2.1.1	Warnings and symbols	6
2.1.2	Scope of regulations	6
2.1.4	Maintenance & repair	6
2.1.5	Electrical safety.....	6
2.1.6	Earth insulation failures	6
2.1.7	Installation	6
2.1.8	Operation.....	7
2.1.9	Fire and explosion.....	7
2.1.10	Dangerous substances	7
2.1.11	Warning regarding life support applications	7
2.2	Transport, lifting and storage	7
2.3	Features.....	8
2.3.1	General	8
2.3.2	Construction	8
2.3.3	Control	8
2.3.4	Installation	8
2.3.5	Documentation	8
2.4	Main components to identify	9
2.4.1	Kubota-based models	9
2.4.1	Mitsubishi-based models.....	10
3	TECHNICAL INFORMATION	11
3.1	Explanation of functional parts	11
3.1.1	Control system	11
3.1.2	AC Permanent Magnet Alternator	11
3.1.3	Engine	11
3.1.4	Starter battery charging.....	11
3.1.5	Alarms and shut-down.....	11
3.1.6	Control	11
3.1.7	Remote control panel	11
3.1.8	Load indicator	11
3.1.9	Fuel	12
3.1.10	Bio-diesel	12
3.1.11	Lubricating oil	12
3.1.12	Cooling liquid	12
3.2	Technical data	13
3.2.1	Two-cylinder genverters	13
3.2.2	Three-cylinder genverters.....	15
4	OPERATION	17
4.1	General	17
4.2	Programmable speed	17
4.3	Operating instructions.....	17
4.3.1	Daily check of oil level.....	17
4.3.2	Summarized operating instructions (daily use)	17
4.3.3	Extended operating instructions.....	17
5	MAINTENANCE	19
5.1	Maintenance intervals.....	19
5.2	Alternator	19
5.3	Engine.....	19
5.3.1	Preliminary instructions.....	19



5.3.2	Bleeding the fuel lines.....	19
5.4	Regular maintenance.....	19
5.4.1	General precautions	19
5.4.2	Servicing after break-in.....	20
5.4.3	Changing engine oil and oil filter cartridge	20
5.4.4	Checking the battery.....	20
5.4.5	Adjusting the V-belt tension	20
5.4.6	Draining water from the fuel tank	21
5.4.7	Replacing the fuel filter.....	21
5.4.8	Changing the air filter element	21
5.4.9	Checking hoses and electrical connections.....	21
5.4.10	Servicing after 800 hours and beyond	21
5.5	Putting out of service	21
6	TROUBLESHOOTING	22
6.1	General	22
6.1.1	Failure codes.....	22
6.2	Alternator/ electrical faults	22
6.2.1	Troubleshooting table for alternator	23
6.2	Engine faults	23
6.2.1	General	23
6.2.2	Troubleshooting table for engine	23
6.2.3	Warnings.....	26
6.2.4	Service address	26
7	SPARE PARTS	27
8	OTHER PRODUCTS FROM WHISPERPOWER.....	28
	Maintenance log	29

Supplier's Declaration of Conformity/Incorporation



1 INTRODUCTION

1.1 GENERAL

This manual serves as a guideline for the safe and effective operation, maintenance and possible correction of minor malfunctions of the two and three cylinder Genverters for mobile applications manufactured and marketed by WhisperPower.

It is therefore essential that every person who works on or with the Genverters should be familiar with the contents of this manual, and that he/she should carefully follow the instructions contained herein. Both safety and durability depend very much on the correct identification, installation and the correct understanding of ratings, features, design, maintenance and operation procedures.

The information, specifications, illustrations and statements contained within this publication are given with our best intentions and are believed to be correct at the time of going to press.

All of the specifications, provisions and instructions contained in this manual apply solely to standard versions of the standard versions of the two and three cylinder Genverters delivered by WhisperPower.

This manual is valid for the following models:

Part no.	Description
41001120	2-cylinder Genverter (Kubota) for mobile use
41001320	3-cylinder Genverter (Kubota) for mobile use
41001220	2-cylinder Genverter (Mitsubishi) for mobile use
41001420	3-cylinder Genverter (Mitsubishi) for mobile use

For other models see other manuals available on our website: www.whisperpower.com.

Our policy is one of continued development and we reserve the right to amend any technical information without prior notice.

Whilst every effort is made to ensure the accuracy of the particulars contained within this publication neither the manufacturer nor the distributor or dealer in any circumstances shall be held liable for any inaccuracy or for the consequences thereof.

1.2 SERVICE AND MAINTENANCE

Regular service and maintenance should be carried out according to the directions in this manual. For service and maintenance, turn to the manufacturer or a dealer.

1.3 GUARANTEE

WhisperPower guarantees that this Genverter has been built according to the principles of good workmanship, according to the specifications in this manual and according to European Community safety regulations.

During production and prior to delivery, all of our Genverters are tested and inspected.

This Genverter's correct operation is subject to guarantee. The period and conditions of this guarantee are laid down in the

general conditions of delivery as registered with the Chamber of Commerce and Industries for the North of the Netherlands number 01120025 and are available on request. The guarantee period is two years, limited to 1000 running hours. Some aspects of our guarantee scheme are given here in more detail:

Guarantee does not cover failures caused by misuse, neglect or faulty installation.

Example 1: Faulty installation

Overheating of the engine or alternator is the most common cause of problems with mobile Genverters. These problems are usually caused by hot air circulation into the radiator or the radiator fan sucking exhaust gasses into the radiators.

The Genverter and other parts should be protected against the influences of the weather and splashing water (with dirt and salt) below the vehicle. Refer to the installation manual for instructions, but remember these are for guidance only as many factors influence the installation of a Genverter. The ultimate responsibility will always be with the owner. If in doubt, ask!

Example 2: Misuse

Long term running with no load or too little load can cause the exhaust to get choked with soot or carbon. Cleaning the exhaust is not covered by guarantee.

Example 3: Neglect

A Whisper Genverter has an option for an auto start/stop mode or interval mode. WhisperPower cannot be held responsible for damage caused by the Genverter running unattended. Oil changes must be carried out according to the maintenance schedule.

Guarantee means that faulty parts are repaired or replaced free of charge. If necessary the whole Genverter unit will be exchanged. Labor necessary to complete repairs on board a vehicle by an authorized service engineer is covered, but is limited to a reasonable number of hours and reasonable rates in relation to the actual repair work that has to be done.

Travel expenses and travel hours are not covered, neither is the labor required to take a Genverter out of a vehicle or for reinstallation. There is no cover for labor needed to get access to the Genverter, for example to remove equipment or parts of the vehicle body.

Goods to be delivered under guarantee will be invoiced. Only after the faulty goods are returned will the invoice be credited. Payment in advance may be required or guaranteed by credit card. If the faulty goods show that the failure was not covered by guarantee, a credit will not be issued. For example, if a Printed Circuit Board is returned with clear damage caused by water, guarantee will be refused.

Freight costs to deliver spares by normal mail or carriers are covered under guarantee. Special services like express mail, overnight delivery, etc. are not covered. Taxes and duties are not covered. For shipments to remote areas any additional costs incurred over normal carriage will be invoiced to the customer.

The cost for returning faulty goods is not covered by guarantee.

If any problem arises which could be subject of guarantee, procedures should be followed as described in the guarantee conditions, unauthorized repairs could lead to further damage and violate the guarantee conditions.



Any work contrary to the guidelines, instructions and specifications contained in this user's manual and the corresponding installation manual, may damage the Genverter and prevent it from meeting its specifications. In all these cases the guarantee may become invalid. Use original spare parts only!

1.4 LIABILITY

WhisperPower does not accept responsibility for damage, injuries or casualties which are the result of operation of the Genverter in specific conditions bringing dangers which could not be foreseen, or could be avoided by additional measures. WhisperPower does not accept liability for damage due to use of the Genverter, possible errors in the manuals and the results thereof.



Automatic start/stop: WhisperPower cannot be held responsible for damage caused by the Genverter running unattended using the auto-start/stop mode or interval mode.



Do not use the Genverter when the vehicle is inside a building or in other enclosed areas. Be aware using the Genverter in wind still conditions, when the exhaust fumes could accumulate under, around or even in the vehicle.



SWITCH OFF THE GENVERTER WHEN THE VEHICLE IS INSIDE BUILDINGS OR IN ENCLOSED AREAS.

1.5 IDENTIFICATION

1.5.1 General

Before using this Genverter it is very important to identify the model correctly. To communicate for service or ordering parts it is also essential to correctly identify the Genverter. For the daily operation of the Genverter it is necessary that the operator knows the correct specifications as well.

1.5.2 Identification plate

All required identification data are on the identification plate. The identification plate also mentions some basic features of the Genverter.

SERIAL NUMBER
The identity of the Genverter is given by the SERIAL NUMBER. Using this number, the manufacturer can trace the specifications of the Genverter.

POWER
The identification plate gives the maximum load in kVA (=kW) calculated with power factor one. When calculating a load one should always take into account the power factor or cos. phi of this load. The resulting load should not exceed the nominal power as shown on the identification plate. Power is rated at an ambient temperature of 25°C. For higher temperatures the

Genverter has to be de-rated. If the radiator fan (12V fan) is driven using power generated by the Genverter, the net power may be less than specified on the identification plate.

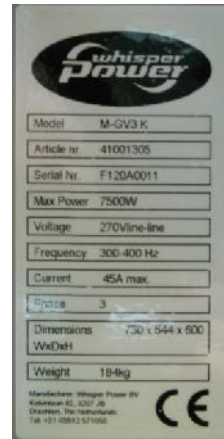

Figure 1: Identification plate

VOLTAGE

The Permanent Magnet Alternator (PMA) generates a variable voltage between 250V and 400V. Depending on the type of installation, this is converted by a DC PowerCube or an AC Power Module for Genverter

FREQUENCY

The Permanent Magnet Alternator output frequency is considerably higher than in in common alternating current installation. The DC PowerCube and WP-PMG (Power Module for Genverter), however, are designed to generate very stable DC and AC outputs from the PMA output.

CURRENT

The maximum allowed current at the specified voltage and power factor.

PHASE

The number of live wires running from the genverter.

WEIGHT

The net dry weight (approximately) in kg. This is without fuel, oil, cooling liquid, packaging and external installation equipment.

CE-MARKING

The "CE" symbol shows that the Genverter is built according to European Community safety regulations. This includes the regulations regarding electric safety and electric magnetic compatibility (EMC) and other relevant directives. Under the Machinery Directive, the Genverter is an incomplete machine and can only comply after installation; refer to the Declaration included in this manual. As the inverter works completely independent from the vehicle's drive system and should not be connected to it in any way, an E-mark is not required.

Safety is also a matter of installation, utilization and operating conditions. See also 2.1.

It is recommended to consult the manufacturer before changing a factory setting. If the Genverter involved is not new, former users may have changed the settings. Check the settings when there is any doubt.

2 GENERAL INFORMATION

2.1 SAFETY

2.1.1 General

The user must always:

- have access to the user's manual;
- be familiar with the contents of this manual. This applies in particular to the paragraphs on safety.

2.1.1.1 Warnings and symbols

Safety instructions and warnings are marked in this manual by the following pictograms:



WARNING

This warning symbol draws attention to special warnings, instructions or procedures which, if not strictly observed, may result in damage or destruction of equipment, severe personal injury or loss of life.



WARNING

Moving machinery. This symbol indicates that a potential hazard exists caused by moving parts and draws attention to special warnings, instructions or procedures which, if not strictly observed, may result in severe personal injury or loss of life.



WARNING

This danger symbol refers to toxic danger caused by Carbon monoxide (CO) and draws attention to special warnings, instructions or procedures which, if not strictly observed, may result in severe personal injury or loss of life.



DANGER

This danger symbol refers to electric danger and draws attention to special warnings, instructions or procedures which, if not strictly observed, may result in electrical shock which will result in severe personal injury or loss of life.



A procedure, circumstance, etc. requiring extra attention.

2.1.2 Scope of regulations

When correctly installed and used under normal conditions, this Genverter fulfills EC safety regulations. This Genverter could be part of an installation or could be used in a way that additional regulations of the EC or other authorities have to be taken into account. Refer to the declaration of conformity/incorporation included in this manual.



In certain situations, additional measures may be necessary. Be aware of wet conditions, explosion hazards, etc.

2.1.4 Maintenance & repair



WARNING

When service has to be carried out while the engine is running, be aware of moving parts.



If the Genverter is switched off during maintenance and/or repair activities, it should be secured against unexpected and unintentional switching on:

- remove the DDC fuse from the local control panel
- remove the connections to the batteries
- be sure that third parties cannot reverse the measures taken.

Use original spare parts only. Always consult the manual before carrying out maintenance.

2.1.5 Electrical safety



Warning signs indicate parts which could be live.



The alternator output (which is the inverter input) can be as high as 400 Volt and is very dangerous. The only way to get access to the high voltage parts is with the help of tools. Never run the Genverter when there is access to these parts. Touching these parts may result in electrical shock which will result in severe personal injury or loss of life.



DANGER

Be aware that people are not used to have 230V available on a vehicle. Put warning signs on wall sockets and on junction boxes. Instruct non-regular users of the vehicle. Warn maintenance personnel of garages doing service on the vehicle.

- Check all wiring at least once a year. Defects, such as loose connections, burned cables, etc. must be repaired immediately.
- Do not work on the electrical system if it is still connected to a current source. Only allow changes to your electrical system to be made by qualified electricians.
- Connections and protection must comply with local standards.

2.1.6 Earth insulation failures

Depending on local regulations and the type of installation, protective measures may be necessary to prevent earth insulation failures.

In the standard delivery "neutral" and "ground" are not connected. Connecting "neutral" and "ground" may be required as part of a specific insulation failure protection system.

2.1.7 Installation

WhisperPower Genverters are not self-contained and have to be properly installed. Installation involves proper ventilation, safe electric connections, safe installation of the starting battery, proper fitting of the cooling system and fuel pipes etc. In enclosed areas, installation includes taking measures to outlet exhaust fumes. Containing carbon monoxide, these are extremely dangerous. Carbon monoxide (CO) is an invisible and odorless gas. Inhalation produces headache, nausea or death. Refer to the installation manual.



Do not use the Genverter when the vehicle is inside a building or in other enclosed areas. Be aware using the Genverter in calm conditions, when the exhaust fumes could accumulate under, around or even in the vehicle.

2.1.8 Operation

WhisperPower Genverters have no external moving parts like fans and V-belts. The fan of the radiator unit is covered by a grid. The hot parts of the engine are covered by the sound shield and therefore these Genverters are very safe when the sound shield is closed.



Nevertheless take note of the triangular signs on the Genverter indicating danger.

- The Genverter should be operated by authorized personnel only.
- Be aware of hot parts and especially parts of the exhaust system and the cooling system.
- If the Genverter is unsafe, fit danger notices and disconnect the battery positive (+) lead so that it cannot be started until the condition is corrected.
- Do not attempt to operate the Genverter with a known unsafe condition. Disconnect the battery positive (+) lead prior to attempting any repairs or cleaning inside the enclosure.
- Always consult the manual before carrying out maintenance.
- Do not change the settings without consulting the manufacturer. Keep a record of setting changes in this manual.

2.1.9 Fire and explosion



Fuels can be flammable. Proper handling limits the risk of fire and explosion.



WARNING

Never use the Genverter in situations where there is danger of gas or dust explosion or where potentially flammable products are present!

- Avoid refilling the fuel tank while the engine is running. When oil or fuel is leaking do not use the Genverter.
- Hydrogen gas generated by charging batteries is explosive. Ensure proper ventilation. Do not smoke and do not allow sparks, flames, or other sources of ignition around batteries.
- Keep a fire extinguisher on hand.
- In case of fire, do not open the sound shield. To avoid serious injury or death from fire, shut down engines, generator sets and blowers. However, if you do open the sound shield, immediately discharge the entire contents of a portable fire extinguisher into the canopy.
- Poor electrical connections or using wiring which is not suited for the rated currents can cause overheating and possibly fire.

2.1.10 Dangerous substances

Fuels, oils, coolants, and battery electrolyte can be hazardous to personnel if not handled properly. Do not swallow or have skin contact with these liquids. Do not wear clothing that has been contaminated by fuel or lubricating oil.

The gaskets used in the Genverter are free of asbestos. However, gaskets containing asbestos can still be found. Avoid inhaling particles of this material as this may result in fatal diseases. Therefore it is a good habit to be careful with gaskets.

On no account allow unprotected skin to come into contact with the injector spray as the fuel may enter the blood stream with fatal results.

Engines may be fitted with seals or O-rings manufactured from "Viton" or similar material. When exposed to abnormally high temperatures in excess of 315°C an extremely corrosive acid is produced which cannot be removed from the skin. If signs of decomposition of the material are evident, or if in doubt, always wear heavy duty disposable gloves.

2.1.11 Warning regarding life support applications

The WhisperPower two and three cylinder Genverters are not intended to be used as a component of any life support system unless a specific written agreement pertaining to such intended use is executed between the manufacturer and WhisperPower. Such agreement will require the medical equipment manufacturer either to contract additional reliability testing of the Genverter and/or to commit to undertake such testing as a part of the manufacturing process. In addition the medical equipment manufacturer must agree to indemnify and not hold WhisperPower responsible for any claims arising from the use of the Genverter in the life support equipment.

2.2 TRANSPORT, LIFTING AND STORAGE



When lifting the Genverter avoid any risk of personal injuries. In particular, do not stand under the Genverter.

- Use soft slings to avoid damage
- The engine has a lifting eye which can be used to take the Genverter out of the capsule. It can also be used to lift the complete Genverter including the capsule.
- After transporting the Genverter check for damage before installation.
- Long term storage can have detrimental effects on engine and alternator. The engine should undergo an engine preservation procedure (refer to the maintenance chapter.)
- Condensation may occur on alternator windings. To minimize condensation, store the Genverter in a dry and warm storage area.
- While the battery is stored it should be recharged every 12 weeks.



2.3 FEATURES

2.3.1 General

The WhisperPower two and three cylinder Genverters combine 2 and 3 cylinder engines with highly efficient Permanent Magnet alternators. The voltages and frequencies produced, however, require the Genverter to be connected to a WhisperPower PowerCube or Power Module producing clean DC or AC output. This is an original concept, which is cost-effective as well as easy on installation.

2.3.2 Construction

The Genverter incorporates a diesel engine which has a permanent magnet alternator in the flywheel. The engine is mounted on a steel base frame and mounted securely on a double set of anti-vibration mounting pads in a sound attenuated canopy. The output of the power from the alternator will be between 300V-400Hz and 400V-500Hz, depending on the engine speed. The engine speed is set to strike a balance between fuel efficiency and comfort. All cables and hoses are guided through the capsule's sides.

2.3.3 Control

The Digital Control system of the Genverter is based on microprocessor technology. Several operating modes and automatic start/stop functions can be programmed and monitored (refer to Digital Diesel Control user's manual).

All functions can be set from the remote control panel, which comes as standard with the Genverter, including a 15 m cable.

2.3.4 Installation

The Genverter is not self-contained and is only operable after proper installation using additional accessories and installation materials such as a starter battery, fuel supply and an exhaust system.

Installation accessories are listed in the installation manual and are available through the supplier of the Genverter.

2.3.5 Documentation

Included in the delivery are:

- This user's manual (number: 40200676)
- An installation manual (number: 40200786)
- A DDC operating manual (no. 40200801).
- A DDC quick reference guide (no. 40200142)

The user's manual contains a list of important maintenance and spare parts as well as a chapter on maintenance and problem solving. Manuals in other languages are available on request.

2.4 MAIN COMPONENTS TO IDENTIFY

2.4.1 Kubota-based models

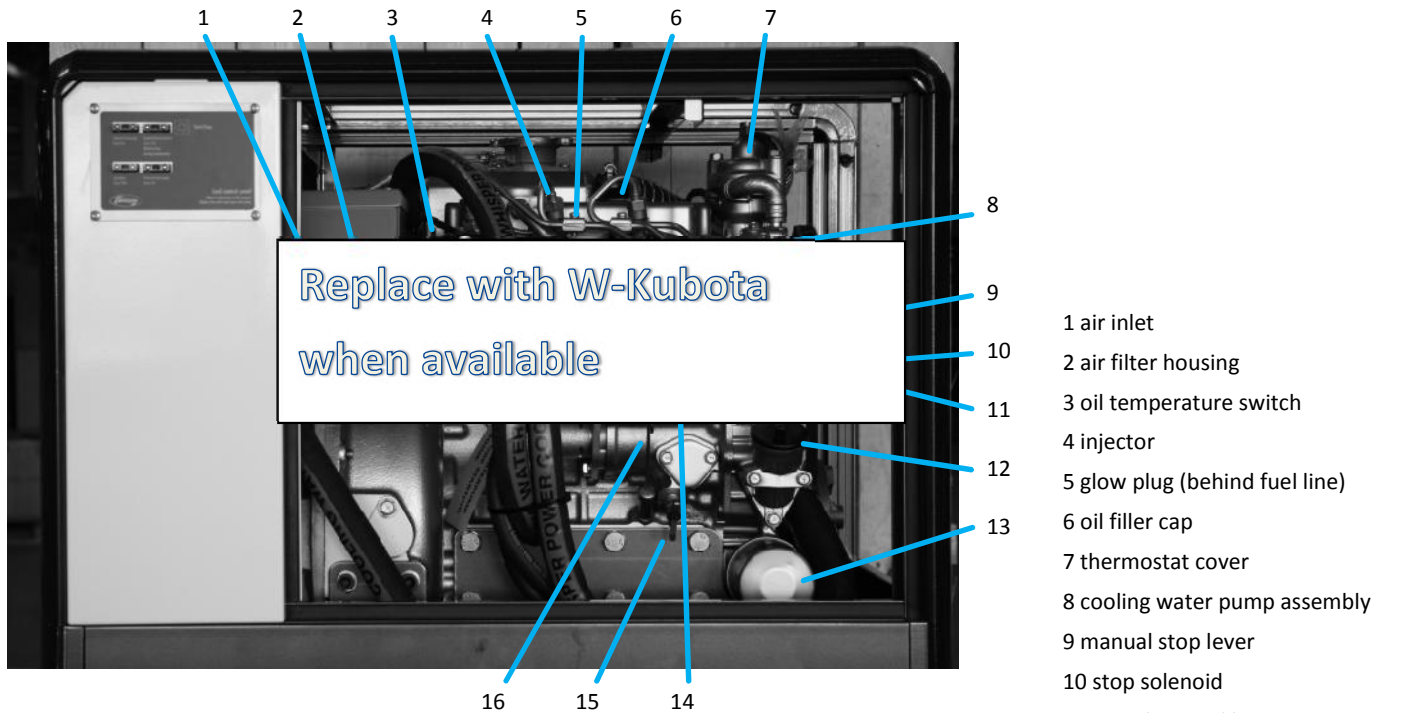

Figure 2: Main components at service side (three-cylinder Kubota)

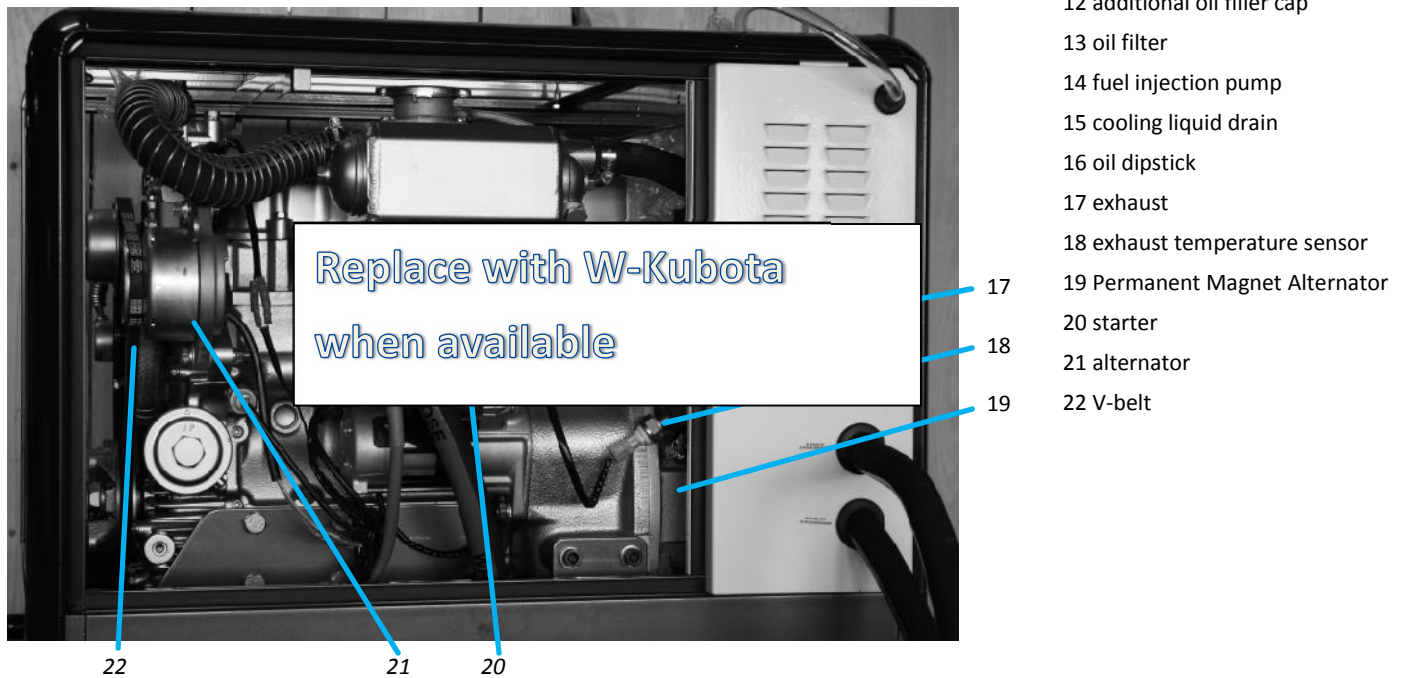

Figure 3: Main components at service side (three-cylinder Kubota)

2.4.1 Mitsubishi-based models

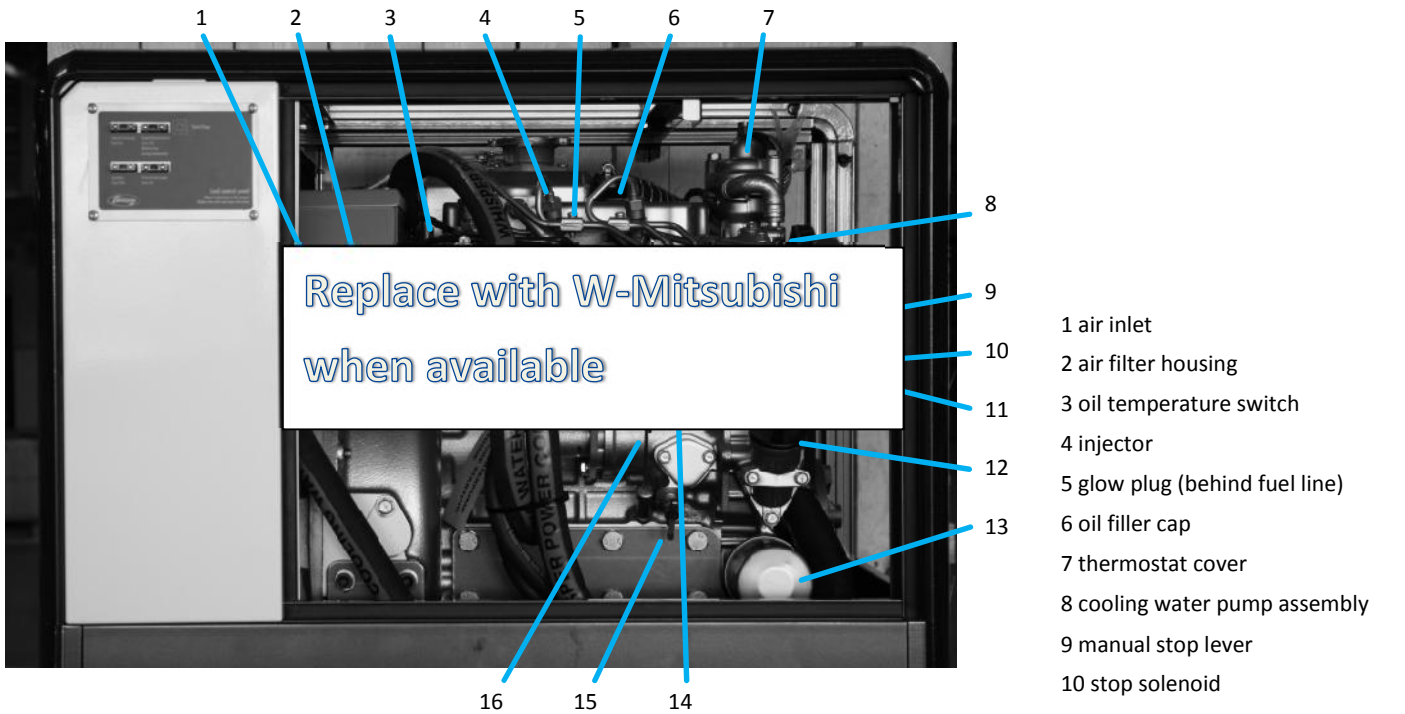

Figure 4: Main components at service side (three-cylinder Kubota)

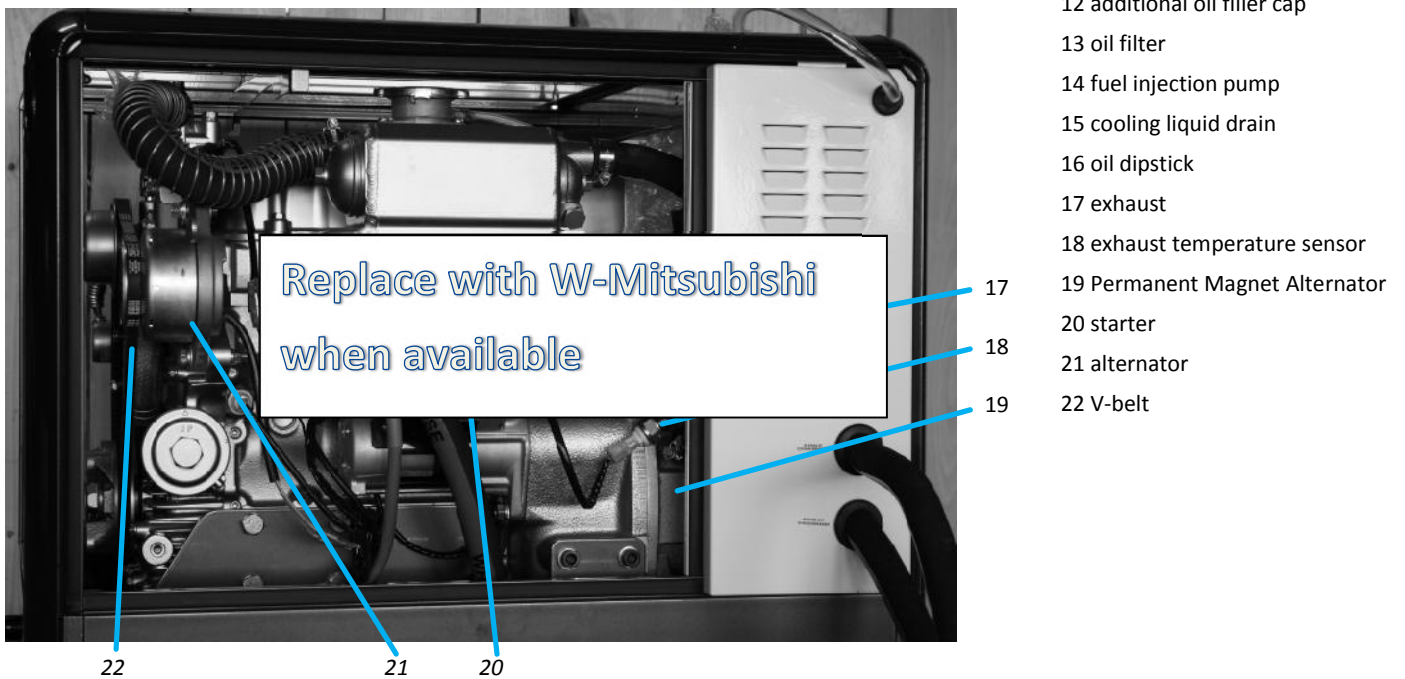

Figure 5: Main components at service side (three-cylinder Kubota)

3 TECHNICAL INFORMATION

3.1 EXPLANATION OF FUNCTIONAL PARTS

The WhisperPower two and three cylinder Genverters are highly advanced systems. They combine new technologies from various fields such as engine technology, PM alternator technology and, in the PowerCubes and Power Modules, inverter technology.

3.1.1 Control system

The engine is monitored and controlled by microprocessors in the Digital Diesel Control system (DDC). The standard electrical engine control system is 12 Volt negative earth. Non-earth return (ungrounded) is available as option. Check your identification data to determine which system is being used. Either system is of the "energize to run" type: it stops when the 12 V DC voltage is taken away. Highly advanced, the DDC controls the engine and also operates as a management system to control the engine in combination with the PowerCube.

3.1.2 AC Permanent Magnet Alternator

The Three Phase Permanent Magnet Alternator is incorporated in the flywheel and has a very high efficiency of at least 94%. The output of the power from the alternator will be between 250V-300Hz and 400V-500Hz, depending on the engine speed. As the efficiency is very high, little cooling is needed. The alternator and the engine use the same cooling system.

3.1.3 Engine

The Genverter has a Kubota engine fine-tuned by WhisperPower. The engine has indirect injection and was designed to meet the highest emission standards. The cooling system can be used for CHP (Combined Heat and Power production). Contact WhisperPower for additional information.

Further details are in the data sheet in 3.2.

3.1.4 Starter battery charging

The engine is equipped with a 12.5A (two-cylinder version) or 40A (three-cylinder version) alternator for charging the starter battery. The voltage is regulated at $\pm 14.4V$.

3.1.5 Alarms and shut-down

In the event of malfunctioning this will be indicated by the failure light, details will be shown on the display and the engine will be shut down. Two parameters are being monitored: oil pressure and oil temperature.

All alarm switches are closed when no malfunction occur. A contact is cut in the event of an alarm. This means that the Genverter will not work when the alarm switches are broken or when there is a loose wire. The system therefore is intrinsically safe. The panel will display details about the alarm.

3.1.6 Control

The Genverter can be operated by push buttons on the panel on the unit or on the remote control. Pushing the START button will activate the control system and will start the engine automatically. Pushing the STOP button will stop the engine and the electrical system will be deactivated. When using the Genverter in an automatic mode the engine will start when

power is demanded, e.g. because of low batteries or another "event" that triggers the starting operation. Various automatic modes are available through the remote control panel. Refer to the DDC Operating manual for more information.



Figure 6: Local control panel

3.1.7 Remote control panel

The remote control panel is used to make the various settings. It also displays parameters such as Voltage, Hz, Amps, and many others (refer to the DDC manual for details).

The connection between the remote control panel and the Genverter control unit is made using plug-in connectors. A 10 m communication cable is in the standard supply. If necessary, a longer or shorter cable can be supplied. Multiple remote control units can be put in parallel by using the connectors on the back of the units (refer to installation instructions).

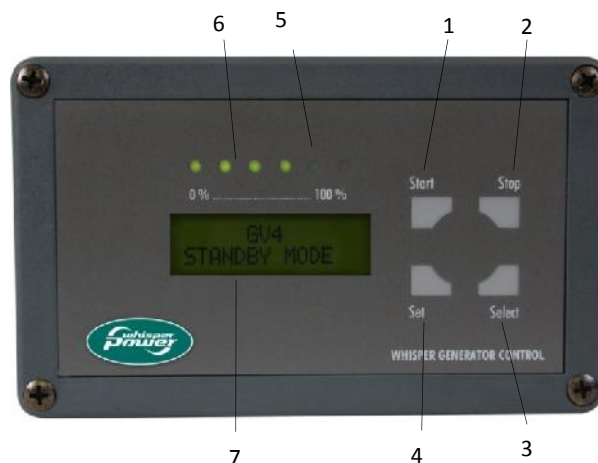

Figure 7: Digital diesel remote control panel

- | | |
|------------------|-----------------------------|
| 1. Start button | 5. Failure lamp |
| 2. Stop button | 6. Generator load indicator |
| 3. Select button | 7. Display |
| 4. Set button | |

3.1.8 Load indicator

On the local panel and on the remote control the load will be indicated on the display and/or by the LED bar.

3.1.9 Fuel

Specification

The engine must only be used with diesel fuel oil conforming to the standards for use in modern diesel engines. It is essential that the fuel should be free from water and contaminants. The following specifications must be complied with:

Diesel Fuel Specification	Location
EN590:96	European Union
BS 2869-A1 Or A2	UK
No. 2-R, No 1-D, ASTM D975-94	USA
GB252	China
ISO 8217 DMX	International
JIS K2204 Grade No.2	Japan
KSM-2610	Korea

Diesel pre-heater

Optionally, a diesel pre-heater can be installed. This is a useful in extremely cold conditions. In this case the fuel filter will be inside the canopy and there will be a heating element upstream of the filter preventing the formation of paraffin crystals in the diesel and clogged filters as a result. The system's operation is temperature-dependent and is controlled by a separate switch to turn it "on" or "off".

3.1.10 Bio-diesel

The use of diesel fuels to a maximum blend of 5% (by volume) of Fatty Acid Methyl Esters (FAME) known on the market as B5 diesels is allowed as far as these fuels comply with EN 14214 (Europe) or ASTM D-6751 (USA), as appropriate.

Bio-fuels should be supplied by recognized and authorized suppliers only. "Self-blended fuels" may cause engine damage and will affect warranty.

Please note that free methanol in FAME may result in corrosion of aluminum parts. Free water in FAME may result in choked fuel filters and injectors and may result in increased bacterial growth.

3.1.11 Lubricating oil

1 Specification:

The oil must be suitable for oil changes as specified in the maintenance chapter. The engine must be run on heavy duty lubricating oil meeting the requirements of API class CF, CF-4, CH-4, CI-4 or CI-4 plus. It is recommended to use a well-known brand.



It is very important to use the correct oil specification. Do not mix different types of oil. Higher API class oils and synthetic oils are to be avoided.

2 Oil viscosity:

We recommend 10W40 multi grade oil. In very cold or hot conditions, a special grade could be applied according to the Viscosity Chart below:

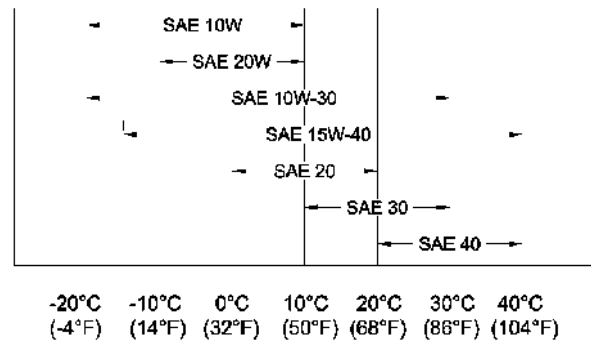

Figure 8: Viscosity chart

3 Oil capacity:

The content of the crankcase and oil filter, is as specified below (approximate data):

GV/2 Kubota	2.8 L
GV/2 Mitsubishi	3.2 L
GV/3 Kubota	4.1 L
GV/3 Mitsubishi	4.4 L



Do not overfill with lubricating oil as this may have a detrimental effect on engine performance.

4 Lubricating oil pressure:

- Minimum at idle: 49 kPa (0,5 kgf/cm² - 7psi).
- Normal at 3000 rpm: between 147 and 490 kPa (1,5 up to 5 kgf/cm² - 21 up to 71 psi).
- Minimum at 3000 rpm: 98 kPa (1,0 kgf/cm² - 14 psi).

3.1.12 Cooling liquid

The engine is cooled by cooling liquid. Use only long-life type G12+ cooling liquid in order to minimize maintenance. The capacity of the engine's cooling system is approximately 3.5 liters. The capacities of the radiator and piping have to be taken into account as well.

Initially, the engine can be filled via the filling cap on the exhaust manifold. Fill up till the level is just below the filling cap. Filling of the alternator cooling system and additional filling of engine cooling system has to be done via the expansion tank. When the engine is on temperature the liquid will expand and the redundant liquid will be pressed into the expansion tank. This tank has to be filled up till the mark. The tank has an overflow connection, which can be used to connect an open hose to drain the overflow of the cooling liquid to outside the vehicle.



3.2 TECHNICAL DATA

3.2.1 Two-cylinder genverters

	Genverter Model	
Mobile version, dry exhaust	41001120 - 2-cylinder genverter (Kubota) for mobile use	41001220– 2-cylinder genverter (Mitsubishi) for mobile use
General information		
System output	8kW/6kVA	8kW/6kVA
Peak power 200msec	200%	200%
Low rpm setpoint	1800rpm	1800rpm
Max rpm setpoint	3200rpm	3200rpm
Nominal rpm	2500 .. 2800rpm	2500 .. 2800rpm
Sound level @ 7m	54dBA	55dBA
Sound level @ 1m	65dBA	65dBA
Cooling	Single radiator	Single radiator
Exhaust	Dry type, 1" OT	Dry type, 1" OT
Speed governor	Mechanical	Mechanical
Starter battery capacity	12V / 80Ah	12V / 80Ah
Standard supplies	Digital remote panel (10 m cable), fuel filter, fuel lift pump, user and installation manuals	
Available options	Installation kits, non-earth return (ungrounded), spare part kit, longer or shorter DDC cables	
Mechanical specifications		
Dimension (h × w × d)	600 × 650 × 545mm	600 × 650 × 545mm
Dimension mounting (h × w)	340 × 618, 230 × 618mm	340 × 618, 230 × 618mm
Dry weight excl. sound shield	124kg	132kg
Dry weight incl. sound shield	154kg	162kg
Color	RAL9010 signal white RAL9020 metallic black	RAL9010 signal white RAL9020 metallic black
Engine		
Engine model	Kubota Z482	Mitsubishi L2E
Emission Regulation	Tier 4, EPA	Tier 4, EPA
Engine performance intermittent SAEJ1995	8.9kW @ 3600rpm 7.6kW @ 3000rpm	11.3kW @ 3600rpm 9.4kW @ 3000rpm
Engine performance continuous @ 25°C ambient temperature	7.8kW @ 3600rpm 6.6kW @ 3000rpm	9.9kW @ 3600rpm 8.5kW @ 3000rpm
Number of cylinders	2	2
Displacement	0.479 l	0.635 l
Bore & stroke	67 × 68mm	76 × 70mm
Air intake system	Naturally aspirated	Naturally aspirated
Air consumption	0.95 m ³ /min	1.22 m ³ /min
Fuel oil	Diesel fuel oil (ASTM No. 2-D)	Diesel fuel oil (ASTM No. 2-D)
Fuel consumption @ full load	275 g/kWh	297 g/kWh
Engine cooling	Indirect water cooled	Indirect water cooled
Nominal operation voltage	12VDC	12VDC
Alternator	12,5A	40A
Operating principle	Energize to run	Energize to run
Starter power requirement	0.8 kW	0.8 kW
Monitoring and control	Digital Diesel Control	Digital Diesel Control
Protections	Oil temperature and pressure, coolant temperature	Oil temperature and pressure, coolant temperature
Local control	Start/stop & maintenance	Start/stop & maintenance
Service interval oil change	200 h	200 h
Oil capacity	Approx. 2.5 l	Approx. 2.9 l
Lubricant	At least CF	At least CF
Alternator		
Type	Permanent Magnet Alternator PM	
Model	HV/SAE5, Delta, 300VAC, 400Hz, 15A	
Output voltage per phase (Delta), no load @ 25°C	118V @ 1800rpm 236V @ 3600rpm	
Output frequency	240Hz @ 1800rpm 480Hz @ 3600rpm	



Configuration	3-phase, Star (for WP-PMG) or Delta (for DC PowerCube)
Nominal power (torque)	40 Nm
Nominal efficiency	94%
Cooling	Radiator cooling
Nominal coolant temperature	40 .. 80°C
Bearing, coupling	Single end bearing, flex plate
Rotor concept	Inner rotor type
Number of phases	3-phase
Insulation class	H
Maximum allowed winding temperature	175°C
High voltage test	3000V
Regulations and Directives	
CE conformity	
EMC directive	EMC 2004/108/EC
Emission	EN 55022 (Class A/B household/light industrial use)
Harmonics	EN 61000-3-2 (<16A, Class A)
Dips, variations, flicker	EN 61000-4-11, EN6100-3-3 (designed to meet)
Immunity	EN 61000-6-2, marine suitable or better
LV directive	LVD 2006/95/EC
Safety	EN 60950 Safety of information technology equipment
	EN 60335-1 Safety of household and similar electrical appliances, Part 1
	EN 60335-2-29 Household and similar electrical appliances – Safety - Particular requirements for battery chargers
Vibration and shock levels (designed to meet)	EN 68-2-6, 5-50Hz velocity, max. 20mm amplitude, suitable for marine and mobile high vibration environments
E-marking (designed to meet)	Automotive EMC 2004/104/EC
EN (designed to meet)	EN 60945
ABYC (designed to meet)	American Boat & Yacht Council
UL or CSA (designed to meet)	UL 458



3.2.2 Three-cylinder genverters

	Genverter Model	
Mobile version, dry exhaust	41001320 – 3-cylinder genverter (Kubota) for mobile use	41001420 – 3-cylinder genverter (Mitsubishi) for mobile use
General information		
System output	10kW/8kVA	10kW/8kVA
Peak power 200msec	200%	200%
Low rpm setpoint	1800rpm	1800rpm
Max rpm setpoint	3200rpm	3200rpm
Nominal rpm	2500 .. 2800rpm	2500 .. 2800rpm
Sound level @ 7m	54dBA	55dBA
Sound level @ 1m	65dBA	65dBA
Cooling	Single radiator	Single radiator
Exhaust	Dry type, 1"OT	Dry type, 1"OT
Speed governor	Mechanical	Mechanical
Starter battery capacity	12V / 80Ah	12V / 80Ah
Standard supplies	Digital remote panel (10 m cable), fuel filter, fuel lift pump, user and installation manuals	
Available options	Installation kits, non-earth return (ungrounded), spare part kit, longer or shorter DDC cables	
Mechanical specifications		
Dimension (h x w x d)	600 x 720 x 545mm	600 x 720 x 545mm
Dimension mounting (h x w)	340 x 680, 230 x 680mm	340 x 680, 230 x 680mm
Dry weight excl. sound shield	141kg	149kg
Dry weight incl. sound shield	171kg	179kg
Color	RAL9010 signal white RAL9020 metallic black	RAL9010 signal white RAL9020 metallic black
Engine		
Engine model	Kubota D722	Mitsubishi L3E
Emission Regulation	Tier 4, EPA	Tier 4, EPA
Engine performance intermittent SAEJ1995	13.3kW @ 3600rpm 12kW @ 3000rpm	16.9kW @ 3600rpm 14.7kW @ 3000rpm
Engine performance continuous @ 25°C ambient temperature	12.2kw @ 3600rpm 10.4kW @ 3000rpm	15.2kw @ 3600rpm 13.2kW @ 3000rpm
Number of cylinders	3	3
Displacement	0.719 l	0.952 l
Bore & stroke	67 x 68mm	76 x 70mm
Air intake system	Naturally aspirated	Naturally aspirated
Air consumption	1.22 m ³ /min	1.34 m ³ /min
Fuel oil	Diesel fuel oil (ASTM No. 2-D)	Diesel fuel oil (ASTM No. 2-D)
Fuel consumption @ full load	275 g/kWh	297 g/kWh
Engine cooling	Indirect water cooled	Indirect water cooled
Nominal operation voltage	12VDC	12VDC
Alternator	40A	40A
Operating principle	Energize to run	Energize to run
Starter power requirement	0.8 kW	0.8 kW
Monitoring and control	Digital Diesel Control	Digital Diesel Control
Protections	Oil temperature and pressure, coolant temperature	Oil temperature and pressure, coolant temperature
Local control	Start/stop & maintenance	Start/stop & maintenance
Service interval oil change	200 h	200 h
Oil capacity	Approx. 3.8 l	Approx. 4.1 l
Lubricant	At least CF	At least CF
Alternator		
Type	Permanent Magnet Alternator PM	
Model	HV/SAE5, Delta, 300VAC, 400Hz, 15A	
Output voltage per phase (Delta), no load @ 25°C	98V @ 1500rpm 196V @ 3000rpm	
Output frequency	200Hz @ 1500rpm 400Hz @ 3000rpm	
Configuration	3-phase, Star (for WP-PMG) or Delta (for DC PowerCube)	
Nominal power (torque)	40 Nm	



Nominal efficiency	94%
Cooling	Radiator cooling
Nominal coolant temperature	40 .. 80°C
Bearing, coupling	Single end bearing, flex plate
Rotor concept	Inner rotor type
Number of phases	3-phase
Insulation class	H
Maximum allowed winding temperature	175°C
High voltage test	3000V
Regulations and Directives	
CE conformity	
EMC directive	EMC 2004/108/EC
Emission	EN 55022 (Class A/B household/light industrial use)
Harmonics	EN 61000-3-2 (<16A, Class A)
Dips, variations, flicker	EN 61000-4-11, EN6100-3-3 (designed to meet)
Immunity	EN 61000-6-2, marine suitable or better
LV directive	LVD 2006/95/EC
Safety	EN 60950 Safety of information technology equipment
	EN 60335-1 Safety of household and similar electrical appliances, Part 1
	EN 60335-2-29 Household and similar electrical appliances – Safety - Particular requirements for battery chargers
Vibration and shock levels (designed to meet)	EN 68-2-6, 5-50Hz velocity, max. 20mm amplitude, suitable for marine and mobile high vibration environments
E-marking (designed to meet)	Automotive EMC 2004/104/EC
EN (designed to meet)	EN 60945
ABYC (designed to meet)	American Boat & Yacht Council
UL or CSA (designed to meet)	UL 458

4 OPERATION

4.1 GENERAL

The genverter is operational after full installation and filling up with fuel, engine lubricating oil and cooling liquid, connecting the battery and connecting the digital remote control panel.

4.2 PROGRAMMABLE SPEED

At the time of commissioning, the engine rpm are set to meet the output requirements of the installation.

4.3 OPERATING INSTRUCTIONS

4.3.1 Daily check of oil level

Be sure to keep the oil level between upper and lower limits of the oil gauge. Too much oil may cause a drop in output or excessive blow-by gas, while too little oil may seize the engine's rotating and sliding parts.

Procedure:

- 1 Check the engine oil level before starting or more than 5 minutes after stopping the engine.
- 2 Remove the oil dipstick, wipe it clean and reinsert it. Take the dipstick out again, check the oil level gauge and reinsert the dipstick.

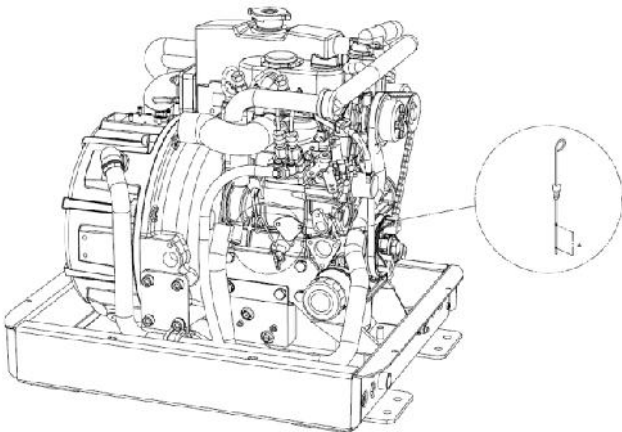

Figure 9: Oil dipstick (similar on all models)

- 3 If the oil level is too low, remove the oil filler plug, and add new oil to the prescribed level.
- 4 After adding oil, allow the oil to come down to the oil pan before checking the oil level again.

4.3.2 Summarized operating instructions (daily use)

Routine "pre-start" checks:

- 1 Check oil level and cooling liquid level.
- 2 For systems incorporating PMG: power source selector switch (off/shore power/generator power) in "off" position, or switch of all consumers in the usual way. If a Whisper Switch of Transfer System Switch is installed, this operates automatically.
- 3 Switch on battery switch (if installed).
- 4 Fuel valve: open.

Starting:

Push the start button and hold for a second to initiate the fully automatic starting procedure.

In operation checks:

- 1 Check for abnormal noise or vibration
- 2 Check the output parameters on the remote control display
- 3 For systems incorporating PMG: switch power source selector to "generator" position. If a Whisper Switch of Transfer System Switch is installed, this operates automatically.
- 4 Before loading the generating set up to its maximum, have it run warm. Continuous load should be restricted to 70 % of maximum load.

Stopping the genverter:

- 1 If the genverter has been running under full load for a longer period, do not shut it down abruptly. Reduce the electrical load to about 30% of the rated load and let it run for around 5 min.
- 2 Press the STOP button.
- 3 Switch to another AC power source, if available

4.3.3 Extended operating instructions

Check when starting the first time or after a longer period of rest:

- 1 If there is any damage caused by transport or installation.
- 2 Check if the installation conforms to the installation instructions.
- 3 Ensure the engine is free to turn without obstruction.
- 4 Check all hoses and hose connections for leaks.
- 5 Check all cables and terminal connections.

Routine "pre-start" checks:

- 1 Check engine oil level. The genverter switches off in the event of insufficient oil pressure. Even when the oil level is too low, the oil pressure can be high enough not to trip an alarm. Do not run the engine with the oil below the lowest mark, because a smaller volume of oil will become contaminated considerably quicker than a larger volume. Moreover, a low level may affect cooling. Therefore, we recommend daily oil-checks. Check oil level prior to starting the engine or at least 5 minutes after the engine has stopped.
- 2 Check for leakages.
- 3 Switch off all devices.
- 4 Switch on the battery switch (when installed).

Starting the genverter:

By pushing the start button and holding it for a second, the electric system is activated. You can monitor the procedure on the display of the remote control panel. First, the fuel pump will prime the fuel for a few seconds

(settable); the starter will then crank the engine until it starts. While starting the alarms are blocked (this is achieved by pushing the Start/Stop button). The alarms are reactivated after 10 seconds.

Warm up the engine without load for 3 minutes. A restart protection prevents cranking the engine when it is already running, which could cause damage.



Never use ether or gasoline to facilitate a cold start as it could damage the engine.

Checks once the engine is in operation:

- 1 Check for abnormal noise or vibration.
- 2 Check the output parameters on the remote control display.
- 3 Observe the exhaust at the rated load.

The exhaust must be free from soot. Do not allow the engine to run with visible smoke from the exhaust without investigating the cause, as this may result in an expensive breakdown.

Engine load during longer operation:

During the first 50 hours of running, the continuous load should be restricted to 70 % of the maximum load. Running at no load or light load for long periods in the first 50 hours may cause cylinder glazing and high oil consumption.

Avoid overloading the genverter. Overloading occurs when the electrical load (demand) is so high that by the diesel engine has trouble driving the alternator. It causes the engine to run rough, while using oil and excessive fuel and producing soot. The engine may even stop. The genverter should therefore be loaded at the maximum rated power for short periods (2-3 hours) only! The high peak current is meant for the ability to start electrical devices that need a high current for starting especially electric motors and compressors (from a still stand state).

In order to prolong the genverter's life expectancy, the nominal electrical demand of the system should not exceed 70% or the genverter's rated maximum load. Please note this when switching on your electrical equipment! Nevertheless, the genverter is designed so as not to overheat, even under extreme conditions.

Do not run the genverter for very long periods at no load or at very low load. When this is necessary, increase the load to at least 70% for one hour in 10 hours. Long term running at too low load will cause the exhaust to be choked by carbon (soot).



Neither remove the battery while the engine is running nor remove any electrical cable while the battery is connected to the circuit. Only disconnect the battery with the engine stopped and all switches in "OFF" position.

Stopping the genverter:

- 1 Avoid stopping the genverter abruptly after a long period of operation at high load. Prior to switching off the genverter, decrease the load (i.e. turn off most electrical consumers) and let the genverter run at low load for approx. 5 minutes to allow the engine to cool down sufficiently. Another reason to switch off electrical consumers prior to stopping the genverter is the voltage drop that occurs as the engine comes to a halt.

If the genverter is operating in a hot environment and is not allowed to cool down, excessive heat in the engine may trip the "high temperature" alarms. This will prevent restarting of the engine for some time.

- 2 Press the STOP button.
- 3 Switch to another 230V power source, if available.



If the engine is not running and the 'failure' and 'charging' LEDs are blinking, press the stop button in order to prevent the starter battery from being drained.

5 MAINTENANCE

5.1 MAINTENANCE INTERVALS

Service level			break-in	1	2	3	4
		before each start	after 35-50 h	every 200 h/ 6M*	every 400 h/ 12M*	every 800 h/ 24M*	every 1600 h/ 36M*
Lubricating oil	check oil level	●					
	change oil and oil filter cartridge		●	● (12M)			
	check lubricating oil pressure						□
Cooling system	check cooling liquid level	●					
	check and clean radiator				●		
	check hoses					●	
	check cooling system						●/□
Exhaust	check exhaust		●				
Nuts & bolts	check all and tighten where necessary		●				
Electrics	check all electrical connections		●			●	
	check/adjust V-belt tension			●			
	check battery (acid level, connections)			●			
Fuel system	drain water from tank			●			
	replace fuel filter				●		
	check fuel hoses					●	
	check injection nozzles and injection pressure						□
	check injection pump						□ (3200h)
Air supply	check air strainer and filter element				●		
Cylinder head	Retighten cylinder head bolts and readjust valve clearance					●/□	
* Whichever comes first. ● Can be done by user. Corrective action to be taken whenever necessary. □ WhisperPower service center to be contacted.							

5.2 ALTERNATOR

The alternator does not require maintenance.

5.3 ENGINE

5.3.1 Preliminary instructions

The first service on the engine should be carried out after 50 running hours. This period also applies after a major overhaul. During the first 50 hours, the engine should receive special attention:

- Long periods of light or no load running in the first 50 hours may lead to cylinder glazing and high oil consumption.
- For the same reason it is of the greatest importance to use the right oil specification.

5.3.2 Bleeding the fuel lines

When the engine is started up for the first time or after it has run out of fuel, the fuel system may need to be primed. Push the start button activating the electric system and activating the fuel pump. When more time is needed to bleed, hold the "Start/Stop" button on the local control panel (so not on the remote panel). While the button is held, the pump will work, but the unit will not start. Hold as long as necessary to bleed the system

5.4 REGULAR MAINTENANCE

5.4.1 General precautions

All regular maintenance can be carried out when the enclosure is open. When oil and dirt have gathered in the enclosure, measures have to be taken to prevent oil from being spilled.



CAUTION!
Risk of personal injury, fire and/or electric shock

- Be sure to conduct daily checks, periodic maintenance, refueling or cleaning on a level surface with the engine shut off and the control system fuse removed.
- Do not touch muffler or exhaust pipes while they are hot; Severe burns could result.
- Allow the engine to cool down sufficiently, especially before changing the oil or the oil filter cartridge. Oil can be hot and cause burns.
- Contact with engine oil can damage your skin. Put on gloves when using engine oil. If you come in contact with engine oil, wash it off immediately.
- When changing engine oil, dispose it according to local regulations.
- When cleaning any parts, do not use gasoline but use regular cleanser.
- Always use proper tools, that are in good condition. Make sure you understand how to use them, before performing any service work.
- Be sure to tighten all bolts lest they should be loose. Tighten the bolts by the specified torque.
- Do not put any tools on the battery, or battery terminals may short out. Severe burns or fire could result. Detach the battery from the engine before maintenance.

5.4.2 Servicing after break-in

- Change engine oil and replace the oil filter (refer to 5.4.3).
- Check and tighten nuts, bolts, and unions, paying particular attention to the fuel system and using the torque chart below.

Standard torque chart			
Size	M6x1.0	M8x1.25	M10x1.5
Nm*	10.8±1.0	25.5±2.9	49.0±4.9
* Apply 80% torque when tightening bolts to aluminum alloy.			

- Observe the exhaust at the normal full load. The exhaust must be free from soot. Do not allow the engine to run with a dirty exhaust without investigating the cause as this may result in an expensive breakdown. When ramping up RPM the engine will probably produce some smoke. After stabilizing on the right RPM for the load the exhaust should be free from soot.
- Check the electrical connections.

5.4.3 Changing engine oil and oil filter cartridge

- 1 Run the engine until it is on temperature, stop it and let it cool down sufficiently to allow safe working.
- 2 Drain oil through the dipstick hole using a vacuum pump as commonly used in garages.

- 3 Put some tissues under the oil filter cartridge.
- 4 Remove the old cartridge with a filter wrench.
- 5 Apply a film of oil to the gasket for the new cartridge.
- 6 Screw in the cartridge by hand. When the gasket contacts the seal surface, tighten the cartridge not too firmly, by hand.
- 7 Remove the oil filler cap on top of the engine, refill the engine with oil (approx. 2.8/3.2 l for two-cylinder model, 4.1/4.4 l for three-cylinder model). The lower figures apply to Kubota-based genverters, the higher figures to Mitsubishi-based genverters. Allow the oil to come down to the oil pan and check the oil level.
- 8 The oil level should be as close as possible to the maximum level. Add (or drain) oil as necessary.

NOTE: When the genverter runs less than 200 hours a year, the oil should be changed yearly.

5.4.4 Checking the battery

- Check battery terminals for corrosion
- Check the battery acid level (not applicable when sealed batteries are used).

5.4.5 Adjusting the V-belt tension

Before adjusting belt tension, inspect the belt for glazing, cracks, or dryness. A worn or damaged belt should be replaced.

- 1 Apply moderate thumb pressure to the belt between the pulleys. When the belt is pressed in the middle of the span, the deflection should be between 7 mm and 9 mm.
- 2 If the tension is incorrect, loosen the alternator mounting bolts and, using a lever placed between the alternator and the engine block, pull the alternator out until the deflection of the belt falls within acceptable limits, then tighten the alternator mounting bolts.

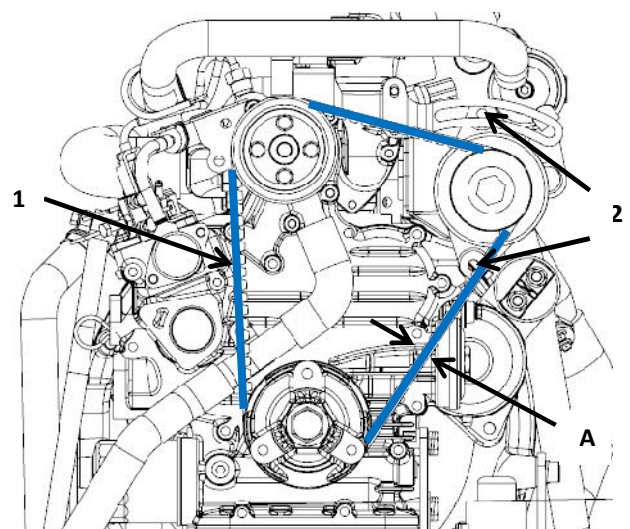

- (1) Alternator belt (A) 7 mm to 9 mm under a load of 10 kgf
 (2) Bolt and nut

Figure 10: Alternator belt (similar on all models)

5.4.6 Draining water from the fuel tank

NOTE: This procedure is unusual on mobile installations. It is included for completeness.



When handling fuel, make sure there are no open flames or other fire hazards near the engine. Wipe off any spilled fuel completely. Spilled fuel can ignite and cause fire.

If fuel gets mixed with particles of foreign matter such as dust, dirt, or water, it can cause not only a decrease of output but also malfunctions of the fuel system. To avoid such problems, drain fuel tank as described below.

1. Position an oil pan (capacity of 2 liters or more) under the drain cock of fuel tank.
2. Open the drain cock of fuel tank and drain at least 1 or 2 liters of fuel.
3. Make sure that all water and particles of foreign matter are discharged with the fuel. Close the drain cock.

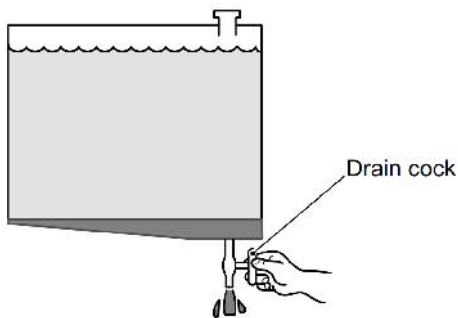

Figure 11 : Draining water from fuel tank

5.4.7 Replacing the fuel filter

Filter change depends on the level of contamination of the fuel, but should be done at least every 400 running hours. A clogged filter results in a lack of output of the engine and irregular running. Before changing the filter, clamp off the supply line. The arrow on the filter housings indicates the flow direction. Remove the hoses from the old filter and fit the new filter.

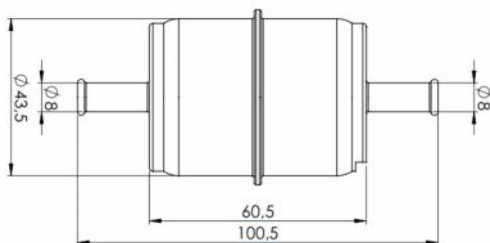

Figure 12: Fuel filter (similar on all models)

5.4.8 Changing the air filter element

The genverter is standard supplied with an air inlet filter element. Filter change depends on air quality.

Procedure:

1. Unscrew the cover in order to gain access to the filter.
2. Clean the foam around the element with compressed air and clean the strainer element.
3. Check the air filter and replace it when necessary (do not clean the air filter element).
4. Put back the cover and retighten the screws.

5.4.9 Checking hoses and electrical connections

Visually check cooling hoses, fuel hoses and electrical wiring, paying particular attention to abrasion, wear and corrosion. Have items replaced when necessary.

5.4.10 Servicing after 800 hours and beyond

This includes the items described above, but also procedures requiring a professional diesel mechanic. Contact your WhisperPower Service Centre. Please find some essential data for Kubota-based genverters below:

- Valve clearance: from 0.145 mm to 0.185 mm when the engine is cold.
- Rocker arm bracket nut M6 × 1: from 9.81 nm to 11.2 Nm
- Cylinder head screw M8 × 1.25: from 38 Nm to 42 Nm.

5.5 PUTTING OUT OF SERVICE

When not using the genverter for a longer period it is recommended to perform an engine preservation procedure.

1. Clean the engine.
2. Loosen the fuel suction pipe and fuel return and put them in a can with preservation diesel fuel.
3. Run the engine until it is on temperature, stop it and let it cool down sufficiently to allow safe working.
4. Drain the hot engine oil and refill with preservation oil.
5. Disconnect the battery and store it in a dry place free of frost and charge it regularly.
6. Close inlet and outlet openings with tape.
7. Protect the genverter against the influences of bad weather conditions.

This method of preservation will be sufficient for 6 months. Change oil before using the engine again.

6 TROUBLESHOOTING

6.1 GENERAL

If any problem should occur, check basic conditions and examine all external wiring, switch gear and circuit breakers. Also check if measuring instruments give the correct value. If in doubt, measure directly on the alternator terminals with an independent instrument.

If during these measurements the engine immediately stops after starting and an error code is displayed at the remote control panel ("AC VOLTAGE"), the Genverter can be restarted

by means of a "service start" in the service menu (see "service start" in the user's manual of the Digital Diesel Control). Started this way, the Genverter will keep running for 2 minutes before it stops. This offers you the possibility to carry out measurements to investigate the cause of the failure. This procedure should only be carried out by an experienced electrician.

6.1.1 Failure codes

A failure code is displayed when a failure at the Genverter is detected. A warning code is displayed when a parameter deviates from the setting.

Warning code	Problem
NO WARNING	None (no warning was detected)
LOW STARTBAT	Voltage of the start battery (BAT1) is below setting
NO BAT2	No second battery detected or voltage is below 5V while nominal voltage is set at 12V or 24V check connections/ fuses/ polarity of the second battery)
LOW BAT2	Voltage of the second battery (BAT2) is below setting
COMMUNICATION	Communication error between the panel and the Genverter. Check the cable connection between the panel and the control unit.
OIL PRESS HIGH	The pressure switch in the cooling system indicates a too high oil pressure
OIL PRESSURE	The oil pressure in the lubrication system is too low
ENGINE TEMP	Temperature engine oil temperature is too high

Failure code	Problem
NO FAILURE	None (no failure was detected)
COMMUNICATION	Communication error between the panel and the Genverter
LOW BAT1	Starter battery voltage (BAT1) too low
PM ALTERNATOR	PM alternator voltage is not OK
OIL TEMP	Oil temperature too high
OIL PRESSURE	Oil pressure failure (lubricating oil pressure too low)
SOFTWARE INV	Software failure in inverter
COMM ERROR INV	Communication between inverter and interface lost
FAILURE TO START	No start signal

6.2 ALTERNATOR/ ELECTRICAL FAULTS



Beware of parts which are live! The alternator generates voltage up to 650 V.



Remove 3 A fuse from the control panel while working on the Genverter in order to prevent the engine from starting.

6.2.1 Troubleshooting table for alternator

PROBLEM	CAUSE	SOLUTION
No output (voltage) at all	• Circuit breaker "off" or faulty fuse	Check switches and fuses and measure directly on the alternator to exclude external causes.
	• Low engine RPM	Check the engine RPM and adjust (refer to special procedures)
	• Alternator failure	Contact WhisperPower Service
Genverter output voltage too low when no load is on it and RPM is above 2500 RPM	• Alternator failure	Contact WhisperPower Service
Genverter output voltage too low under load, but OK in no load condition	• Genverter is overloaded	Switch off a load; reduce number of consumers
	• Insufficient engine RPM	Increase minimum RPM setting
	• Engine RPM drops when loaded	Refer to "Engine speed drops" section in 6.2

6.2 ENGINE FAULTS



Remove 3 A fuse from the control panel while working on the Genverter in order to prevent the engine from starting.

6.2.1 General

When the engine is not cranking well, starting problems almost always originate from battery problems or poor battery cable connections.

When the engine does crank, starting problems almost always originate from lack of fuel or air bubbles in the fuel pipes.

A failure code is displayed when a hardware failure at the engine is detected.

6.2.2 Troubleshooting table for engine

PROBLEM	CAUSE	SOLUTION
Diesel engine fails to crank; no response at all	• Faulty fuse on the control panel	Replace fuse
	• Battery switch off	Switch on
	• Batter completely empty	Charge or replace battery
Diesel engine fails to crank, the starter makes clicking noises, or the engine cranks very slowly.	• Almost certainly this is a battery problem. Display will indicate "LOW BAT1"	Check battery voltage. Recharge the battery. Inspect battery terminals and cables for a good electrical connection (inspect for corrosion, tattered wires, etc.)
	• Wiring system faulty	During the normal starting process, the battery voltage drops to 11V (with a fully charged battery). If the voltage does not drop during starting, the electrical connection is faulty. If the battery voltage drops lower than 11V, then the battery has been discharged too deep.
	• Starter broken	Repair the starter motor
	• Engine lubricating oil too thick	Change oil, using a lower viscosity grade



PROBLEM	CAUSE	SOLUTION
Starter is turning engine smoothly, but engine fails to start	• Out of fuel or faulty fuel, water in the fuel	Fill up with fuel or replace with better quality
	• Fuel solenoid is not opening (no “click” can be heard)	Check wire connections and circuitry to solenoid. (Refer to DC wiring diagram)
	• Fuel lift pump is not working	Check fuel filter and fuel lift pump: clean or replace if necessary
	• Air in fuel lines	Bleed air from fuel system (refer to maintenance section)
	• Blocked injector	Have the injector tested and cleaned if necessary
	• Wrong valve clearance	Adjust valve clearance
	• Low compression because of dirty valves	Contact WhisperPower service department for advice
Starter is turning engine smoothly, but engine runs irregularly after starting	• Loss of compression by wear out or damage	Repair by WhisperPower service
	• Faulty glow plug	Replace faulty glow plug. Consider replacing both or all three taking into account the number of starts completed.
Engine runs irregularly	• Unsuitable or contaminated fuel	Fill up with fuel or replace by better quality
	• Lack of fuel	
	• Air in the fuel pipes	Bleed air from fuel system (refer to maintenance section)
	• Choked fuel filter	Check fuel filter and replace if necessary
	• Disturbances on the electrical system/ user side	Check if electrical load is fluctuating
	• Faulty fuel lift pump	Check and repair or replace
	• Choked air filter	Check the air intake
	• Lack of air	
	• Choked exhaust system, exhaust blocked	Check the exhaust piping, inspect inside of manifold
	• Faulty actuator	Replace faulty parts. Contact WhisperPower service department for advice.
	• Blocked injector	Have the injector tested and cleaned if necessary
	• Wrong valve clearance	Adjust valve clearance
	• Lack of fuel	Check fuel supply system: fuel pump and filter
Engine speed drops	• Genverter overloaded	Reduce the electrical load (switch off some consumers)
	• Fuel problem	Check fuel supply and clean fuel filter
	• Too much oil.	Drain oil to proper level
	• Lack of intake air.	Check air intake; clean air filter
	• Choked exhaust system, exhaust blocked.	Check the exhaust piping; inspect inside of manifold
	• Faulty actuator	Contact WhisperPower service department for advice
	• Defective alternator (windings or other)	Genverter must be sent to manufacturer for repair of damaged bearing or winding



PROBLEM	CAUSE	SOLUTION
	<ul style="list-style-type: none"> • Damaged engine 	Repair by WhisperPower service
Engine does not stop on command	<ul style="list-style-type: none"> • Fuel solenoid is not switching off • Loss of control 	<p>Faulty Digital Diesel Control unit. Stop the engine manually using the stop handle.</p> <p>Check wire connections to stop solenoid. Check solenoid valve function. Replace if necessary.</p>
Engine exhaust smokes	<ul style="list-style-type: none"> • Faint blue smoke - generally the result of light load • Heavy blue smoke - caused by lubricating oil: oil level too high, worn cylinder, stuck, broken or worn piston rings. • When the engine RPM is ramping up to react at a load step some smoke may be unavoidable. • Wrong setting of minimum RPM. • Sooty black smoke –incomplete combustion caused by: overload, choked air filter, air inlet temperature too high, unsuitable fuel or water in fuel. • Valve clearance incorrect. • Continuous running with very low load. 	<p>Increase load.</p> <hr/> <p>Check the oil level Check the compression</p> <hr/> <p>No action required.</p> <p>Readjust minimum rpm setting Check the fuel.</p> <p>Check for overload Check the air filter Adjust minimal RPM setting</p> <p>Readjust valve clearance</p> <p>Increase load and have the engine run for a few hours</p>
Engine starts, but stops after 10 up to 30 seconds	<ul style="list-style-type: none"> • Protection system stops the engine; this can be caused by oil pressure failure, loose wire or faulty alarm switch. Digital Diesel Control will help to indicate failure. • Faulty alarm switch/sensor 	<p>Refer to Chapter 3 and page 24 and the DDC operating manual for information on the alarm system. Bypassing a switch can help to confirm the failure. But be aware: running with a by-passed alarm switch can cause damage!</p> <p>Replace the switch. By-passing the switch makes it possible to keep running. But be aware: running with a by-passed alarm switch can cause damage!</p>
Engine stops by itself	<ul style="list-style-type: none"> • Overload or short circuit • Lack of fuel • Coolant temperature too high (>105°C) • Oil pressure low (oil pressure switch tripped) • Air or water in the fuel. • Blocked air or fuel filter. • Loss of compression by wear out or damage. 	<p>Switch off the consumers and test for short circuit.</p> <hr/> <p>Check fuel supply system: tank level, fuel lines, pump, filter, valves, etc.</p> <hr/> <p>Check cooling system</p> <hr/> <p>Check oil level Check oil pressure and have engine repaired by WhisperPower if necessary.</p> <hr/> <p>Check and clean</p> <hr/> <p>Repair by WhisperPower service.</p>

PROBLEM	CAUSE	SOLUTION
Loss of power	<ul style="list-style-type: none"> • Wrong measurement. 	Check if the load is measured correctly. Does the Amp meter show the correct value? When calculating the load by multiplying voltage and amps this should be done using the exact values, taking into account the power factor of the consumers. When in doubt, measure the power directly using an appropriate instrument.
	<ul style="list-style-type: none"> • Oil level too high 	Drain oil to the correct level
	<ul style="list-style-type: none"> • Choked fuel filter 	Replace the fuel filter
	<ul style="list-style-type: none"> • Choked air filter 	Check air inlet openings; clean air filter
	<ul style="list-style-type: none"> • Exhaust blocked 	Check the exhaust system
	<ul style="list-style-type: none"> • Injector blocked 	Have the injector checked
	<ul style="list-style-type: none"> • Loss of compression, sticking or damaged piston ring 	Have the compression measured Clean or replace the rings
Over-temperature	<ul style="list-style-type: none"> • Overload. 	Reduce the load
	<ul style="list-style-type: none"> • Radiator choked by dirt 	Clean radiator
	<ul style="list-style-type: none"> • Hot air circulation in the radiator. 	
	<ul style="list-style-type: none"> • Exhaust choked with carbon 	Clean exhaust
	<ul style="list-style-type: none"> • Cooling circuit failure 	Contact WhisperPower service

6.2.3 Warnings



Genverter must be shut off immediately if:

- Unusual noise comes from Genverter.
- Exhaust gases suddenly color dark.
- Engine failure warning light is on.

6.2.4 Service address

If you cannot correct a problem with the aid of the troubleshooting tables, contact your WhisperPower Service Centre or WhisperPower Netherlands for an extended service list.

Phone: INT +31-512-571555. 7x24 h service.



7 SPARE PARTS

Kubota and Mitsubishi based models

We recommend the following spares for service and maintenance.

	article no.
• Kit A: parts for regular maintenance	40401760 (2/3-cylinder Kubota) 40401860 (2/3-cylinder Mitsubishi)
• Kit B: parts for maintenance + spare parts	40401761 (2/3-cylinder Kubota) 40401861 (2/3-cylinder Mitsubishi)

Refer to the WhisperPower website for an overview of the spare parts kits' contents

DESCRIPTION	GV2 Kubota	GV3 Kubota	GV2 Mitsubishi	GV3 Mitsubishi
Fuel filter	40209030	40209030	40209030	40209030
Fuel lift pump 12V	50201160	50201160	50201160	50201160
V-belt	40403120	40403120	50203120	50203120
Oil filter	40403121	40403121	40203121	40203121
Air Filter	40230007	40230007	40230007	40230007
WPL Oil 4 Ltr.	40222204	40222204	40222204	40222204
WPL Coolant 4 Ltr.	40222214	40222214	40222214	40222214
Water pump complete	40401870	40401870	40201870	40201870
Impeller + gasket / O-ring	40209011	40209011	40209011	40209011
Pump repair kit A			40201471	40201471
Pump repair kit B			40201472	40201472
Local control panel PCB	50209142	50209142	50209142	50209142
Electronic Whisper Control Unit	40401150	40401150	40401150	40401150
Fuses 10 Amps	50212170	50212170	50212170	50212170
Fuses 3 Amps	50212154	50212154	50212154	50212154
Wiring loom complete	40401886	40401886	40401886	40401886
Digital Diesel Remote control panel	40209102	40209102	40209102	40209102
DDC Cable remote control 15 mtr.	50209133	50209133	50209133	50209133
Lube oil pressure switch	50209212	50209212	50209212	50209212
Exhaust temp. switch	50209238	50209238	50209238	50209238
Temperature switch Coolant	50209208	50209208	50209208	50209208
DC Power Cables Red / Black	50201245	50201245	50201245	50201245
Overhaul gasket kit / Seal kit	40403133	40404133	50203033	50204033
Cylinder head gasket kit	40403130	40404130	50203030	50204030
Glow plug,	40403140	40403140	50203040	50203040
Nozzle injector	40403150	40403150	50203050	50203050
Fuel pump (high pressure) complete	40403160	40404160	50203160	50204160
Thermostat	40403145	40403145	50203045	50203045
Gasket thermostat	40403138	40403138	50203038	50203038
Gasket rocker cover	40403137	40404137	50203037	50204037

8 OTHER PRODUCTS FROM WHISPERPOWER

WhisperPower offers a wide range of power-related products. In our PowerBook, these are arranged as follows.

Power Generation

- Diesel generators - Genverter
- Diesel generators - 3000 rpm
- Diesel generators - 1500 rpm
- Installation kits
- AC and DC belt driven generators



Power Conversion

- Sinewave inverters
- Inverter/chargers
- Battery chargers
- Monitoring and control

Power Storage

- AGM and gel batteries
- Lithium-ion batteries
- Battery-related products
- Solar energy



Power Distribution

- Shore power connect
- AC distribution
- Electrolysis prevention
- DC distribution

Hybrid power systems for power generation & propulsion

- 24/ 48VDC based systems up to 15kW
- systems up to 300kW for super yachts



For instant and detailed information, we recommend checking our website: www.whisperpower.com.



Maintenance log	Wartungslogbuch	Journal de maintenance
This log must remain with the generator. In the event of a warranty claim, a copy of this log has to be sent to the manufacturer.	Dieses Logbuch verbleibt an Bord. Im Falle eines Garantieanspruchs muss eine Kopie an den Hersteller geschickt werden.	Ce journal demeure à bord. En cas de prétention à garantie, une copie est à dresser au fabricant.

	Inspection required at: Vorgesehen bei: Inspection exigée après:	Service level: Inspektionskategorie: Catégorie d'inspection:	Hours on indicator : Stand Betriebsstundenzähler : Etat du compteur d'heures:	Inspected by: Prüfer: Contrôleur:	Date: Datum:	*) Seal, stamp & full address of responsible WhisperPower Service Center (only applicable to items marked <input type="checkbox"/>) *) Stempel bzw. volle Adresse der Whisperpower Servicefirma (nur für mit <input type="checkbox"/> markierten Servicearbeiten) *) Cachet et adresse complète du centre de services WhisperPower (seulement pour les travaux marqués <input type="checkbox"/>).
01	35 - 50 h	break-in				
02	200 h	1				
03	400 h	1,2				
04	600 h	1				
05	800 h	1,2,3				*)
06	1000 h	1				
07	1200 h	1,2				
08	1400 h	1				
09	1600 h	1,2,3,4				*)
10	1800 h	1				
11	2000 h	1,2				
12	2200 h	1				
13	2400 h	1,2,3				*)
14	2600	1				
15	2800 h	1,2				
16	3000 h	1				
13	3200 h	1,2,3,4				*)
14	3400 h	1				
15	3600 h	1,2				
16	3800 h	1				
17	4000 h	1,2,3				*)
18	4200 h	1				



	Inspection required at: Vorgesehen bei: Inspection exigée après:	Service level: Inspektionskategorie: Catégorie d'inspection:	Hours on indicator : Stand Betriebsstundenzähler: Etat du compteur d'heures:	Inspected by: Prüfer: Contrôleur:	Date: Datum:	*) Seal, stamp & full address of responsible WhisperPower Service Center (only applicable to items marked <input type="checkbox"/>) *) Stempel bzw. volle Adresse der Whisperpower Servicefirma (nur für mit <input type="checkbox"/> markierten Servicearbeiten) *) Cachet et adresse complète du centre de services WhisperPower (seulement pour les travaux marqués <input type="checkbox"/>).
19	4400 h	1,2				
20	4600 h	1				
21	4800 h	1,2,3,4				*)
22	5000 h	1				
23	5200 h	1,2				
24	5400 h	1				
25	5600 h	1,2,3				*)
26	5800 h	1				
27	6000 h	1,2				
28	6200 h	1				
29	6400 h	1,2,3,4				*)
30	6600 h	1				
31	6800 h	1,2				
32	7000 h	1				
33	7200 h	1,2,3				*)
34	7400 h	1				
35	7600 h	1,2				
36	7800 h	1				
37	8000 h	1,2,3,4				*)
38	8200 h	1				
39	8400 h	1,2				
40	8600 h	1				
41	8800 h	1,2,3				*)
42	9000 h	1				

Supplier's Declaration of Conformity/Incorporation

No. 7015001001

Issuer's name: WhisperPower BV
Issuer's address: Kelvinlaan 82, NL-9207 JB Drachten

Object of the declaration:

WhisperPower two and three cylinder Genverters, model nos. 41001120, 41001220, 41001320 and 41001420, all serial nos.

The object of the declaration described above is in conformity with the requirements of the following Directives and standards, as applicable:

<i>Document</i>	<i>Title</i>
2004/108/EC	EMC Directive
EN 61000-3-2:2006	Electromagnetic compatibility (EMC) - Part 3-2: Limits - Limits for harmonic current emissions
EN61000-6-1: 2007	Electromagnetic compatibility (EMC). Generic standards. Immunity for residential, commercial and light-industrial environments
EN 61000-6-2: 2007	Electromagnetic compatibility (EMC) - Part 6-2: Generic standards - Immunity for industrial environments
EN 61000-6-3: 2007+A1:2011	Electromagnetic compatibility (EMC) -- Part 6-3: Generic standards - Emission standard for residential, commercial and light-industrial environments
2006/95/EC	Low Voltage Directive
EN 60950:2000	Safety of information technology equipment
2004/104/EC	Automotive EMC Directive
2004/26/EC	Non-Road Mobile Machinery Exhaust Emissions Directive
2006/42/EC	Machinery Directive
EN 842:1996+A1:2008	Safety of machinery - Visual danger signals - General requirements, design and testing
ISO 12100:2010	Safety of machinery - General principles for design - Risk assessment and risk reduction

The machinery is incomplete and must not be put into service until the machinery into which it is to be incorporated or the vehicle into which it is to be installed, has been declared in conformity with the provisions of the Directive.

We undertake to transmit, in response to a reasoned request by the appropriate national authorities, relevant information on the partly completed machinery identified above.

Signed for and on behalf of:

WhisperPower BV

M. Favot,
Chief Technical Officer,

Drachten, November 10, 2014

The technical documentation for the machinery is available from:
WhisperPower BV, Kelvinlaan 82, 9207 JB Drachten, Netherlands



Kelvinlaan 82, 9207 JB Drachten, Netherlands

Tel : + 31-512-571550 / Fax : + 31-512-571599

www.whisperpower.com / info@whisperpower.com